

KOBELCO

Performance  Design

SK 75SR

- Bucket capacity:
0.11–0.35 m³
- Engine power:
53.7 kW/2,100 min⁻¹
- Operating weight:
7,800–9,310 kg



Complies with the EU Stage V
exhaust emission regulation

Built for Perfectionists



SK75SR



Performance



Design

SK75SR of KOBELCO has realised a completely new value by harmonising PERFORMANCE – greater efficiency and productivity with an increased power and speed and DESIGN – operator-based operability and comfort, refusing to accept any compromises.

In pursuit of unique and matchless machines which are unforgettable once you use them, KOBELCO will continue to rise to meet every challenge.

THE ULTIMATE IN SIMPLE AND ELEGANT DESIGN

Our pursuit of functional beauty and aesthetic sense produced a new interior design.

Jog dial

This jog dial integrates multiple functions to realise simple operations. Even with gloved hands, the operator can set various machine conditions without stress.

LED backlights

The switches and dials have LED backlights – they provide a bright, clear view in the dark and set a luxurious mood.







UNFORGETTABLE COMFORT

Air suspension seat

A GRAMMER* seat is installed as standard equipment, which achieves excellent shock absorption and superior ride comfort.

*GRAMMER is trademark of GRAMMER AG, registered in Germany and other countries.

Air conditioner blowing from the rear

Air is blown against the operator's waist and the back of their head, offering more comfortable operation.

Lever angles allow for comfortable operations

The operator can move the levers horizontally without twisting their wrist, which reduces the fatigue caused by the operations.



LED door light

The LED interior light automatically turns on when the door is opened or when the ignition is set to OFF. This ensures easy entry and exit at nighttime.

Parallel wipers secure a wide field of view



KOBELCO



04:33



SETTING MENU



PICTURE OF CAMERA



CLOCK SETTING



SCREEN BRIGHTNESS



MAINTENANCE



CONSUMPTION



LANGUAGE SELECTION



PRESSURE RELEASE



SAFETY ON FULL DISPLAY

Standard 3 Sides Safety Camera System

Our high-resolution, large display shows right, left and rear side cameras together. Multiple display allows the operator to customize viewing needs to enhance operator awareness and jobsite safety.

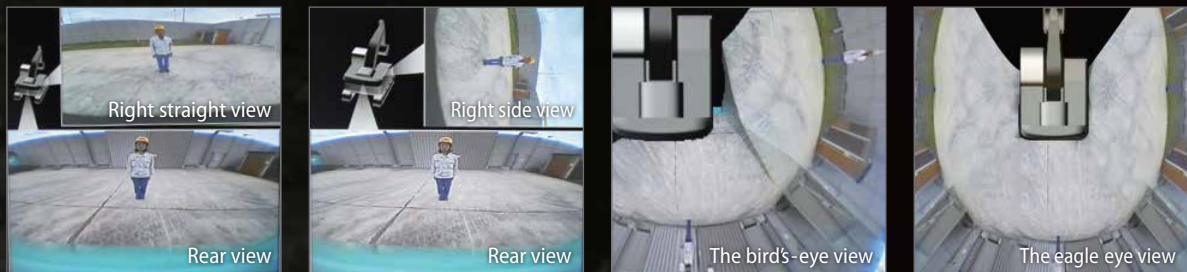

Large 10-Inch Color Monitor

The easy-to-operate menu screen and recognizable icons assist the operator to select the most important information needed to ensure jobsite safety and machine control.



Dial in the Right Information

Simply turn the jog dial to the right or left to select an operational feature, then press the dial to confirm selection.





EXPERIENCING A COMPETENT PERFORMANCE

Our high-power engine complies with STAGE V emission regulations

Compared to previous models, the engine output is significantly increased, which thereby shortens the digging cycle time remarkably. It attains high performances without reducing the speed even when heavy a load is applied or when travelling on a slope.



Model :YANMAR 4TNV98CT

Engine output

Increased by **27.9%**

(Compared to the SK75SR-3E model)

»»» Digging cycle time Shortened by **15%**

(Compared to the SK75SR-3 model)

Loaded boom lifting speed

Increased by **38%**

(Compared to the SK75SR-3E model)

Arm digging speed

Increased by **37%**

(Compared to the SK75SR-3E model)



»» Hill-climbing speed

Increased by **26.9%**

(Compared to the SK75SR-3E model)



GREATER MULTI-FUNCTION CAPABILITIES



Attachment mode





The flow-rate modes of the bucket, breaker, nibbler, and rotating grapple are set before delivery, which allows you to start operating immediately. Mode settings for other attachments, such as the tilt rotator, can easily be added or changed.





TYPES OF ATTACHMENT MODE

	TYPE	MODE	OBJECTIVE OF MODE
CURRENT MODE		Bucket	Balance in operations such as levelling can be adjusted.
		Breaker	Arm regeneration function considering front attachment weight is provided beforehand.
		Nibbler (crusher)	Change of arm speed due to nibbler (crusher) opening/closing is reduced.

	TYPE	MODE	OBJECTIVE OF MODE
NEWLY ADDED MODE		Rotating grapple	Swing operation on slope while raising attachment/equipment becomes possible. Boom 2-speed systems is controlled by proportional valve.
		Processor	N&B flow rate is set to maximum specifically. Regeneration of arm in operation while using front attachment is changed.
		Thumb bucket	Swing operation while raising attachment/equipment and opening thumb bucket becomes possible.
		Tilt rotator	When combined operation with arm is performed, hydraulic interference is prevented.
		Spare mode for custom setting	This mode should be customized at each field. This is provided for front attachment other than those described above.

NON-STOP OPERATION BY iNDr

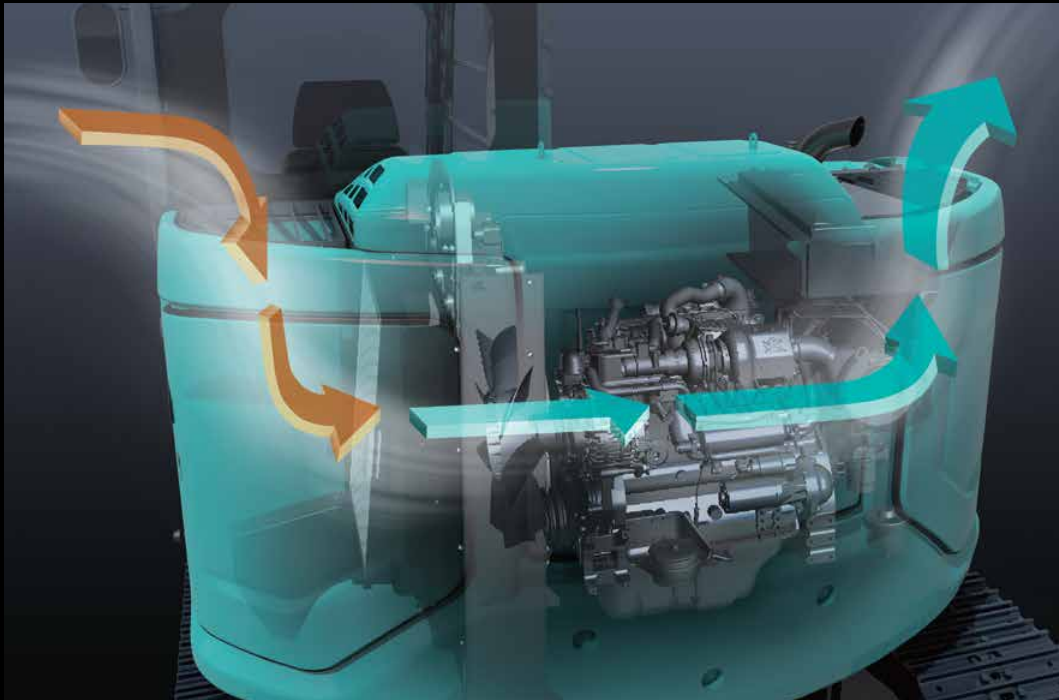

iNDr Filter

A high-density mesh filter blocks dust intruding during air intake. This prevents the cooling device and the air cleaner from clogging with dust and maintains their performances. The ridges of the corrugated filter allow the air to pass through, and the grooves collect the dust, which prevents the filter from clogging.

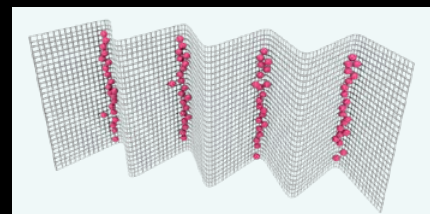

How the filter catches dust



Maintainable on the ground

Portions that require daily maintenance, such as lubrication, have been laid out in easily accessible locations.



Easily removable bonnet

The bonnet can be detached by removing only the bolts, allowing easy access to the inside.

CONVENIENT AND SENSIBLE EQUIPMENT



Engine start password

A password is required when starting the engine for greater security.



Wiper adjustment function

In addition to the intermittent wiper mode and continuous wiper mode, the one-time wiper mode was added.



Parallel wiper Sun screen



Console mount

The console-integrated seat allows for comfortable operation.



DAB+ radio (FM/AM & AUX & USB & Bluetooth* & hands-free telephone)



USB port/12 V power outlet



Smartphone holder

You can use the holder with your smartphone connected to the USB port.



Built-in rear camera/right camera



Standard overhead top guard level II

The standard overhead cab guard can be tilted open with gas damper for easy window cleaning. Meets standard top guard level II requirements. (ISO 10262)



Increased clearance between the upper body and the shoes



Remote control fuel drain cock



Engine oil drain cock

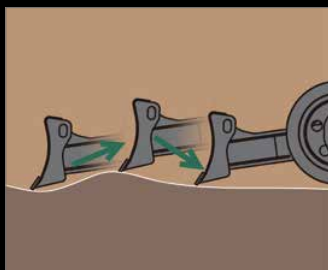

Floating dozer (Option)

Floating dozer assists in easier leveling work.

Floating function can be activated by the switch which is integrated into the dozer control lever.





KOBELCO MONITORING EXCAVATOR SYSTEM

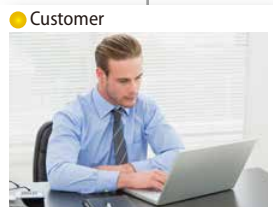

Remote Monitoring for Peace of Mind

KOMEXS (Kobelco Monitoring Excavator System) uses satellite communication and internet to relay data, and therefore can be deployed in areas where other forms of communication are difficult. When a hydraulic excavator is fitted with this system, data on the machine's operation, such as operating hours, location, fuel consumption, and maintenance status can be obtained remotely.

Direct Access to Operational Status

Location Data

Accurate location data can be obtained even from sites where communications are difficult.

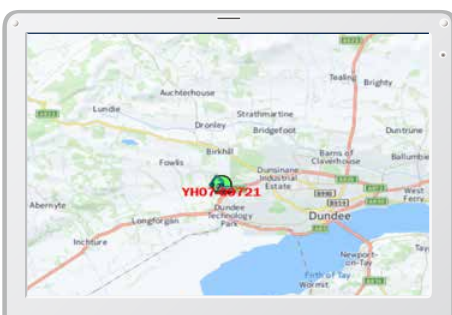

Latest location

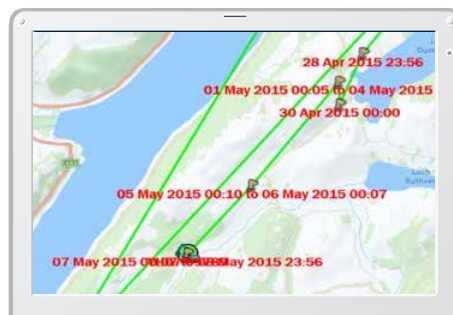

Location records

Period: 11 Apr, 2015 to 10 May, 2015		Search	
Type of Operation	Working Hrs		Ratio
Total Working Hrs	169 Hrs	100%	
Digging Hrs	72.2 Hrs	43%	
Traveling Hrs	18.3 Hrs	11%	
Idle Hrs	15.9 Hrs	9%	
Opt Att Hrs	62.5 Hrs	37%	
Crane Mode Hrs	0 Hrs	0%	

Work data

Operating Hours

- A comparison of operating times of machines at multiple locations shows which locations are busier and more profitable.
- Operating hours on site can be accurately recorded, for running time calculations needed for rental machines, etc.

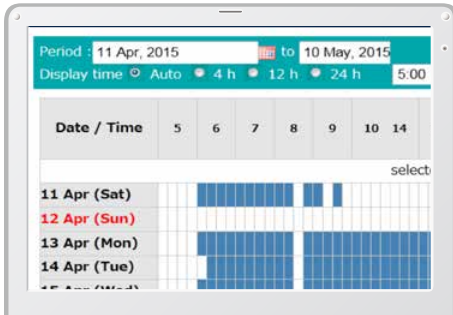

Daily report

Fuel Consumption Data

Data on fuel consumption and idling times can be used to indicate improvements in fuel consumption.

Work mode	Working Hrs	Total Fuel Consumption
H mode	2:06	24.5 L
S mode	0:00	0.0 L
E mode	169:19	1489.7 L
TOTAL	171:25	1514.2 L

Fuel consumption

Graph of Work Content

The graph shows how working hours are divided among different operating categories, including digging, idling, travelling and optional operations.



Work status

Maintenance Data and Warning Alerts

Machine Maintenance Data

- Provides maintenance status of separate machines operating at multiple sites.
- Maintenance data is also relayed to KOBELCO service personnel, for more efficient planning of periodic servicing.

Model	Serial No.	Hour Meter	Engine Oil
SK135SRLC-3/SK140SRL	YH07-09721	734 Hr	434
SK135SRLC-3/SK140SRL	YH07-09789	73 Hr	429
SK210LC-9	YQ13-10454	960 Hr	58
SK210LC-9	YQ13-10481	549 Hr	498
SK75SR-	YT08-30374		

Maintenance

Warning Alerts

This system warns an alert if an anomaly is sensed, preventing damage that could result in machine downtime.

Alarm Information Can Be Received through E-mail

Alarm information or maintenance notice can be received through E-mail, using a computer or cell phone.



Alarm messages can be received on mobile device.

Daily/Monthly Reports

Operational data downloaded onto a computer helps in formulating daily and monthly reports.

Security System

Engine Start Alarm

The system can be set an alarm if the machine is operated outside designated time.

Setting Condition Change
 Start time: 20 : 00
 Release time: 07 : 00
 No Working Whole Day
 Mon Tue Wed Thu Fri Sat Sun
 [] [] [] [] [] [] []
 Clear

Engine start alarm outside prescribed work time

Area Alarm

It can be set an alarm if the machine is moved out of its designated area to another location.

Setting Condition
 Around the current (latest) location 1 Km
 Input Latitude and Longitude
 Latitude1: []
 Longitude1: []
 Latitude2: []
 Longitude2: []
 Map Clear
 Release

Alarm for outside of reset area

Specifications



Engine

Model	YANMAR 4TNV98CT
Type	Four-cycle, water-cooled, direct injection diesel engine, turbo charged, EU Stage V exhaust emission regulation
No. of cylinders	4
Bore and stroke	98 mm × 110 mm
Displacement	3.318 L
Rated power output	52.3 kW/2,100 min ⁻¹ (ISO 9249: with fan) 53.7 kW/2,100 min ⁻¹ (ISO 14396: without fan)
Max. torque	293 N-m/1,365 min ⁻¹ (ISO 9249: with fan) 296 N-m/1,365 min ⁻¹ (ISO 14396: without fan)



Hydraulic system

Pump	
Type	Two variable displacement axial piston pumps + pilot gear pump
Max. discharge flow	2 × 72.5 L/min 1 × 19 L/min
Relief valve setting	
Boom, arm and bucket	29.4 MPa
Travel circuit	29.4 MPa
Swing circuit	24.5 MPa
Control circuit	5.0 MPa
Pilot control pump	Gear type
Main control valves	12-spool
Oil cooler	Air cooled type



Swing system

Swing motor	One fixed displacement piston motor
Brake	Hydraulic; locking automatically when the swing control lever is in the neutral position
Parking brake	Wet multiple plate
Swing speed	11.5 min ⁻¹
Swing torque	17 kN-m
Maximum swing gradient (Loaded)*	24% {14°}

*Value for the least favourable specification



Attachments

Backhoe bucket and combination

Use	Backhoe bucket							
	Standard	Narrow				Wide		
Bucket capacity		ISO heaped	m ³	0.28	0.11		0.14	0.18
	Struck	m ³	0.21	0.09	0.12	0.14	0.18	0.26
Opening width	With side cutter	mm	750	-	480	550	650	870
	Without side cutter	mm	680	400	410	480	580	800
No. of teeth			4	3	3	3	4	4
Bucket weight		kg	210	150	170	180	200	230
Combination	1.71 m arm		⊙	○	○	○	○	△
	2.13 m arm		△	○	○	○	⊙	×

⊙ Standard ○ Recommended △ Loading only × Not recommended



Travel system

Travel motors	2 × axial-piston, two-step motors
Travel brakes	Hydraulic brake per motor
Parking brakes	Oil disc brake per motor
Travel shoes	39 each side
Travel speed	5.0/2.7 km/h
Rated drawbar pull	77.3 kN (SAE J 1309)
Gradeability	58% {30°}



Cab & control

Cab	
All-weather, sound-suppressed steel cab mounted on the silicon-sealed viscous mounts and equipped with a heavy, insulated floor mat	
Control	
Two hand levers and two foot pedals for travel	
Two hand levers for excavating and swing	
Electric rotary-type engine throttle	
Noise levels	
External	98 dB(A) (2000/14/EC)
Operator	73 dB(A) (ISO 6396)
Vibration levels	
Hand/arm*	≤ 2.5 m/s ²
Body*	≤ 0.5 m/s ²

*For the risk assessment according to 2002/44/EC, refer to ISO/TR 25398: 2006



Cylinders

Boom cylinder	110 mm × 916 mm / 115 mm × 944 mm*
Arm cylinder	95 mm × 839 mm / 105 mm × 707 mm*
Bucket cylinder	85 mm × 762 mm / 85 mm × 735 mm*
Offset cylinder*	100 mm × 564 mm
Dozer cylinder	135 mm × 129 mm

*for Offset boom only



Refilling capacities & lubrications

Fuel tank	120 L
Cooling system	12.8 L
Engine oil	11.8 L
Travel reduction gear	2 × 1.3 L
Swing reduction gear	1.5 L
Hydraulic oil tank	44 L tank oil level
	84 L hydraulic system



Working ranges

Unit: m

Boom	3.82 m	
Arm	1.71 m	2.13 m
Range		
a- Max. digging reach	6.48	6.88
b- Max. digging reach at ground level	6.35	6.76
c- Max. digging depth	4.16	4.58
d- Max. digging height	7.41	7.75
e- Max. dumping clearance	5.34	5.67
f- Min. dumping clearance	2.46	2.19
g- Max. vertical wall digging depth	3.73	4.14
h- Min. swing radius	1.73	2.13
i- Horizontal digging stroke at ground level	2.83	3.21
j- Digging depth for 2.4 m (8') flat bottom	3.83	4.31
Bucket capacity ISO heaped m ³	0.28	0.22

Digging force (ISO 6015)

Unit: kN

Arm length	1.71 m	2.13 m
Bucket digging force	60.2	
Arm crowding force	39.4	35.2

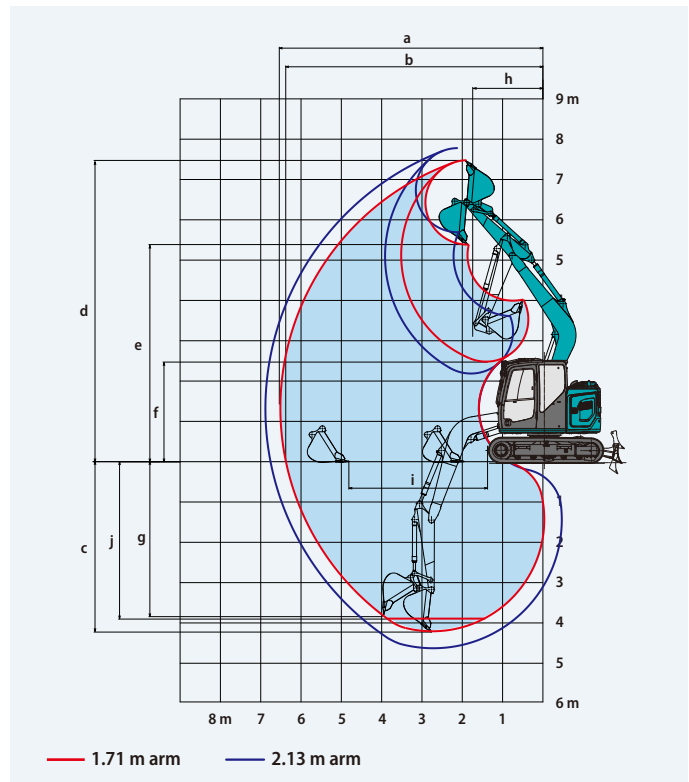

Dimensions

Unit: mm

Arm length	1.71 m	2.13 m
A Overall length (long stroke dozer)	6,340 (6,540)	6,360 (6,560)
B Overall height (to top of boom)	2,560	2,540
C Overall width (narrow specification)	2,300** (2,150)	
D Overall height (to top of cab)	2,570	
E Ground clearance of rear end*	720	
F Ground clearance*	350	
G Tail swing radius (add on counter weight)	1,380 (1,470)	

G'	Distance from centre of swing to rear end	1,380
H	Tumbler distance	2,210
I	Overall length of crawler	2,830
J	Track gauge (narrow specification)	1,850 (1,700)
K	Shoe	450
L	Overall width of upperstructure	2,300
M	Dozer blade (up/down)	360/250 500/500***

*Without including height of shoe lug **450 mm shoe ***Long Stroke Dozer

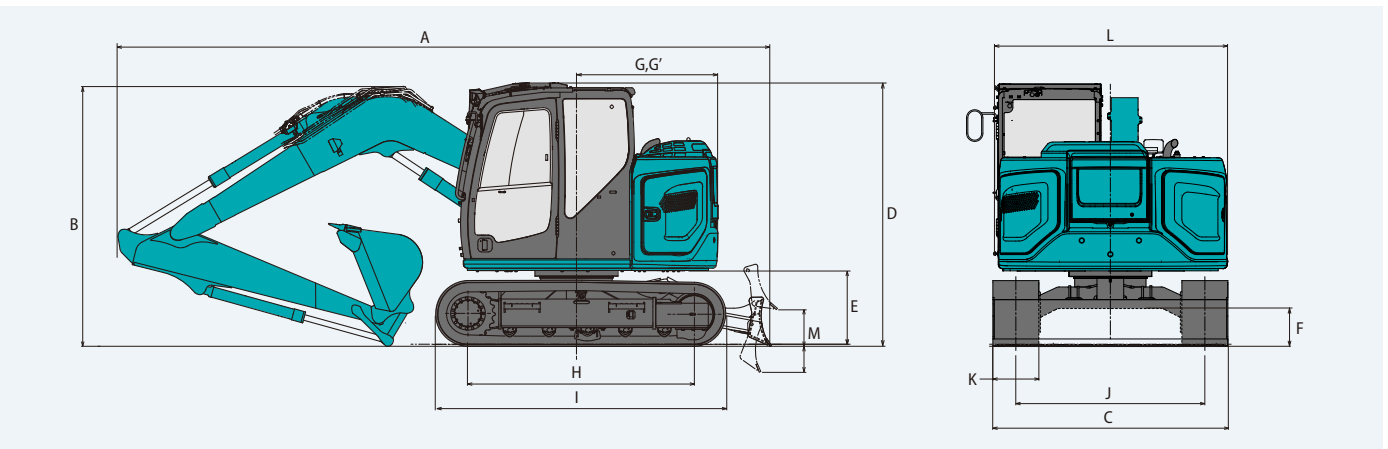

Operating weight & ground pressure

In standard trim, with standard boom, 2.13 m, arm, and 0.22 m³ ISO heaped bucket.

Shaped		Triple grouser shoes (even height)		Rubber pad shoes	Rubber shoes	BS Geogrip shoes
Shoe width	mm	600			450	
Overall width of crawler	mm	2,450			2,300	
Ground pressure	kPa	28	36	37	35	36
Operating weight	kg	8,230	7,980	8,300	7,800	8,020

Lift capacities

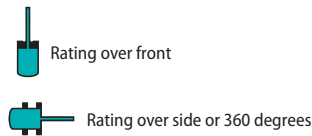
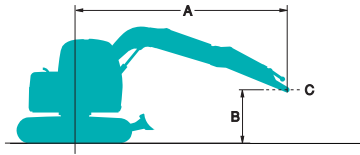









A: Reach from swing centreline to arm top
 B: Arm top height above/below ground
 C: Lift point
 Relief valve setting: 29.4 MPa {300 kgf/cm²}









SK75SR		Boom: 3.82 m Arm: 1.71 m Bucket: Without Counterweight: 700 kg Shoe: 450 mm Dozer: Blade up								
B \ A	1.5 m		3.0 m		4.5 m		At max. reach		Radius	
6.0 m	kg							*2,340	*2,340	2.74 m
4.5 m	kg			*2,400	*2,400			1,800	1,540	4.41 m
3.0 m	kg			*2,910	2,770	1,710	1,460	1,350	1,160	5.18 m
1.5 m	kg			3,040	2,490	1,620	1,380	1,210	1,030	5.44 m
G.L.	kg			2,880	2,350	1,550	1,310	1,240	1,050	5.27 m
-1.5 m	kg	*3,830	*3,830	2,880	2,340	1,550	*1,310	1,490	1,260	4.63 m
-3.0 m	kg			*1,340	*1,340			*1,150	*1,150	3.23 m









SK75SR		Boom: 3.82 m Arm: 1.71 m Bucket: Without Counterweight: 700 kg + 300 kg Shoe: 450 mm Dozer: Blade up								
B \ A	1.5 m		3.0 m		4.5 m		At max. reach		Radius	
6.0 m	kg							*2,350	*2,350	2.74 m
4.5 m	kg			*2,410	*2,410			*1,850	1,680	4.42 m
3.0 m	kg			*2,920	*2,920	1,860	1,600	1,470	1,270	5.18 m
1.5 m	kg			3,300	2,730	1,770	1,510	1,330	1,140	5.44 m
G.L.	kg			3,140	2,580	1,700	1,450	1,360	1,170	5.27 m
-1.5 m	kg	*3,840	*3,840	*2,960	2,580	1,700	1,450	1,630	1,390	4.63 m
-3.0 m	kg			*1,330	*1,330			*1,140	*1,140	3.23 m









SK75SR		Boom: 3.82 m Arm: 1.71 m Bucket: Without Counterweight: 1050 kg Shoe: 450 mm Dozer: Blade up								
B \ A	1.5 m		3.0 m		4.5 m		At max. reach		Radius	
6.0 m	kg							*2,350	*2,350	2.74 m
4.5 m	kg			*2,410	*2,410			*1,850	1,690	4.42 m
3.0 m	kg			*2,920	*2,920	1,870	1,610	1,480	1,280	5.18 m
1.5 m	kg			3,320	2,740	1,780	1,520	1,340	1,150	5.44 m
G.L.	kg			3,160	2,600	1,710	1,460	1,370	1,170	5.27 m
-1.5 m	kg	*3,840	*3,840	*2,960	2,590	1,710	1,450	1,640	1,400	4.63 m
-3.0 m	kg			*1,330	*1,330			*1,140	*1,140	3.23 m

SK75SR		Boom: 3.82 m Arm: 1.71 m Bucket: Without Counterweight: 1,050 kg + 300 kg Shoe: 450 mm Dozer: Blade up								
B \ A	1.5 m		3.0 m		4.5 m		At max. reach		Radius	
6.0 m	kg							*2,340	*2,340	2.74 m
4.5 m	kg			*2,400	*2,400			*1,850	*1,850	4.41 m
3.0 m	kg			*2,910	*2,910	2,060	1,770	1,640	1,420	5.18 m
1.5 m	kg			*3,580	3,030	1,970	1,690	1,490	1,280	5.44 m
G.L.	kg			3,520	2,890	1,910	1,620	1,530	1,310	5.27 m
-1.5 m	kg	*3,830	*3,830	*2,960	2,880	*1,880	1,620	*1,760	1,560	4.63 m
-3.0 m	kg			*1,340	*1,340			*1,150	*1,150	3.23 m

SK75SR		Boom: 3.82 m Arm: 2.13 m Bucket: Without Counterweight: 700 kg Shoe: 450 mm Dozer: Blade up								
A \ B		1.5 m		3.0 m		4.5 m		At max. reach		Radius
										
6.0 m	kg			*2,230	*2,230			*1,920	*1,920	3.47 m
4.5 m	kg			*2,110	*2,110	1,770	1,520	1,520	1,300	4.90 m
3.0 m	kg			*2,620	*2,620	1,720	1,470	1,190	1,020	5.60 m
1.5 m	kg			3,080	2,520	1,620	1,370	1,070	920	5.84 m
G.L.	kg			2,860	2,330	1,530	1,290	1,090	930	5.68 m
-1.5 m	kg	*3,240	*3,240	2,820	2,290	1,510	1,270	1,270	1,080	5.09 m
-3.0 m	kg	*2,720	*2,720	*1,950	*1,950			*1,310	*1,310	3.87 m

SK75SR		Boom: 3.82 m Arm: 2.13 m Bucket: Without Counterweight: 700 kg + 300 kg Shoe: 450 mm Dozer: Blade up								
A \ B		1.5 m		3.0 m		4.5 m		At max. reach		Radius
										
6.0 m	kg			*2,230	*2,230			*1,920	*1,920	3.47 m
4.5 m	kg			*2,110	*2,110	*1,930	1,670	*1,600	1,440	4.90 m
3.0 m	kg			*2,620	*2,620	1,890	1,620	1,310	1,130	5.60 m
1.5 m	kg			3,390	2,780	1,790	1,520	1,200	1,020	5.84 m
G.L.	kg			3,170	2,590	1,700	1,440	1,220	1,040	5.68 m
-1.5 m	kg	*3,240	*3,240	3,130	2,550	1,680	1,420	1,420	1,200	5.09 m
-3.0 m	kg	*2,720	*2,720	*1,950	*1,950			*1,310	*1,310	3.87 m

SK75SR		Boom: 3.82 m Arm: 2.13 m Bucket: Without Counterweight: 1,050 kg Shoe: 450 mm Dozer: Blade up								
A \ B		1.5 m		3.0 m		4.5 m		At max. reach		Radius
										
6.0 m	kg			*2,230	*2,230			*1,920	*1,920	3.47 m
4.5 m	kg			*2,110	*2,110	*1,930	1,680	*1,600	1,440	4.90 m
3.0 m	kg			*2,620	*2,620	1,900	1,630	1,320	1,140	5.60 m
1.5 m	kg			*3,390	2,800	1,800	1,530	1,200	1,030	5.84 m
G.L.	kg			3,190	2,600	1,720	1,450	1,220	1,040	5.68 m
-1.5 m	kg	*3,240	*3,240	3,150	2,570	1,690	1,430	1,420	1,210	5.09 m
-3.0 m	kg	*2,720	*2,720	*1,950	*1,950			*1,310	*1,310	3.87 m

SK75SR		Boom: 3.82 m Arm: 2.13 m Bucket: Without Counterweight: 1,050 kg + 300 kg Shoe: 450 mm Dozer: Blade up								
A \ B		1.5 m		3.0 m		4.5 m		At max. reach		Radius
										
6.0 m	kg			*2,240	*2,240			*1,920	*1,920	3.48 m
4.5 m	kg			*2,120	*2,120	*1,930	1,820	*1,600	1,570	4.90 m
3.0 m	kg			*2,630	*2,630	*2,050	1,770	1,430	1,240	5.60 m
1.5 m	kg			*3,390	3,040	1,950	1,670	1,310	1,130	5.84 m
G.L.	kg			3,450	2,830	1,860	1,580	1,330	1,140	5.68 m
-1.5 m	kg	*3,240	*3,240	*3,170	2,790	1,830	1,560	1,540	1,320	5.09 m
-3.0 m	kg	*2,690	*2,690	*1,930	*1,930			*1,300	*1,300	3.87 m

- Do not attempt to lift or hold any load that is greater than these lift capacities at their specified lift point radius and heights. Weight of all accessories must be deducted from the above lift capacities.
- Lift capacities are based on machine standing on level, firm, and uniform ground. User must make allowance for job conditions such as soft or uneven ground, out of level conditions, side loads, sudden stopping of loads, hazardous conditions, experience of personnel, etc.
- Arm top defined as lift point.
- The above lifting capacities are in compliance with ISO 10567. They do not exceed 87% of hydraulic lifting capacity or 75% of tipping load. Lifting capacities marked with an asterisk (*) are limited by hydraulic capacity rather than tipping load.
- Operator should be fully acquainted with the Operator's and Maintenance Instructions before operating this machine. Rules for safe operation of equipment should be adhered to at all times.
- Lift capacities apply to only machine as originally manufactured and normally equipped by KOBELCO CONSTRUCTION MACHINERY CO., LTD.

Offset boom specifications



Working ranges

Unit: m

Range	Arm	3.82 m					
		1.76 m			2.06 m		
		Max. left	Centre	Max. right	Max. left	Centre	Max. right
a- Max. digging reach		6.11	6.48	5.78	6.39	6.75	6.05
b- Max. digging reach at ground level		5.97	6.34	5.62	6.25	6.62	5.90
c- Max. digging depth		3.94	4.30	3.60	4.24	4.60	3.90
d- Max. digging height		7.17	7.49	6.88	7.40	7.72	7.11
e- Max. dumping clearance		5.11	5.43	4.81	5.34	5.66	5.04
f- Min. dumping clearance		2.13	2.45	1.83	1.85	2.17	1.55
g- Max. vertical wall digging depth		2.96	3.30	2.64	3.27	3.61	2.95
h- Min. swing radius at ground level		1.49	1.21	2.04	1.49	1.31	2.04
i- Horizontal digging stroke at ground level		3.10	3.08	3.09	3.61	3.59	3.64
j- Digging depth for 2.4 m (8') flat bottom		3.55	3.92	3.21	3.89	4.26	3.55
Bucket capacity ISO heaped m ³		0.28	0.28	0.28	0.22	0.22	0.22

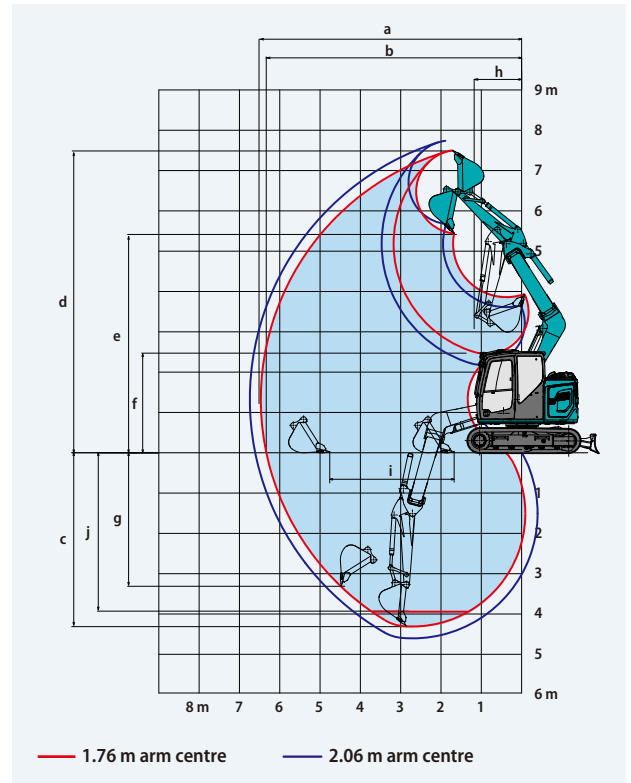

Digging force (ISO 6015)

Unit: kN

Arm length	1.76 m	2.06 m
Bucket digging force	60.2	
Arm crowding force	39.4	35.2



Dimensions

Unit: mm

Arm length	1.76 m	2.06 m
A Overall length	6,160	6,190
B Overall height (to top of boom)	2,330	2,410
C Overall width (narrow specification)	2,300** (2,150)	
D Overall height (to top of cab)	2,570	
E Ground clearance of rear end*	720	
F Ground clearance*	350	
G Tail swing radius (add on counter weight)	1,380 (1,470)	
G' Distance from centre of swing to rear end	1,380	

H Tumbler distance	2,210
I Overall length of crawler	2,830
J Track gauge (narrow specification)	1,850 (1,700)
K Shoe width	450
L Overall width of upperstructure	2,300
M Dozer blade (up/down)	360/250

*Without including height of shoe lug **450 mm shoe

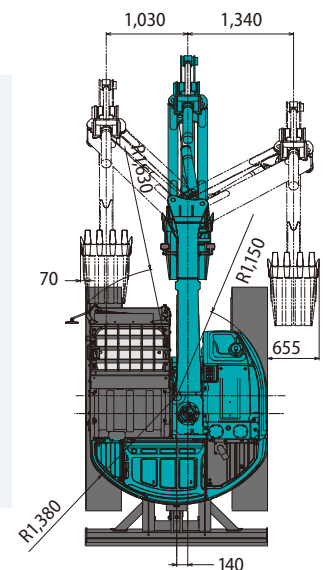
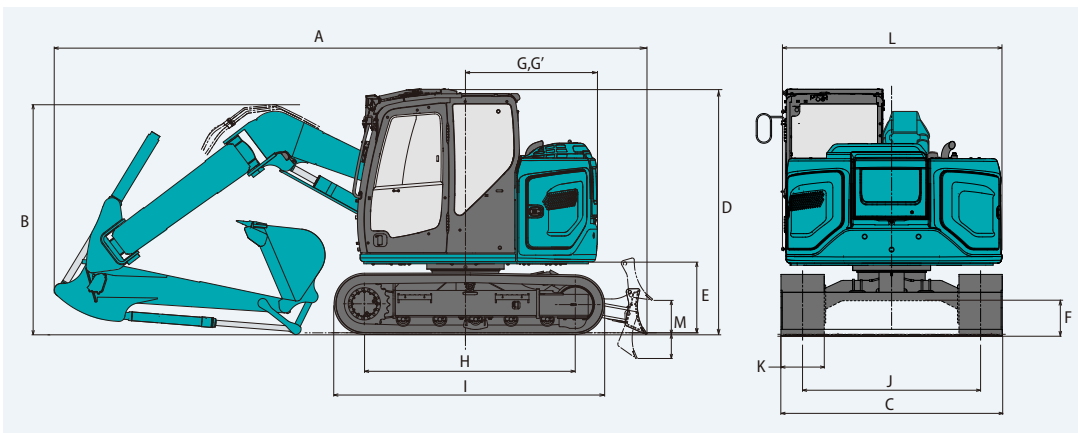

Operating weight & ground pressure

In standard trim, with standard boom, 2.06 m arm, and 0.22 m³ ISO heaped bucket.

Shaped		Triple grouser shoes (even height)		Rubber pad shoes	Rubber shoes	BS Geogrip shoes
Shoe width	mm	600			450	
Overall width of crawler	mm	2,450			2,300	
Ground pressure	kPa	30	39	40	38	39
Operating weight	kg	8,940	8,690	9,010	8,510	8,730

Offset boom lifting capacities

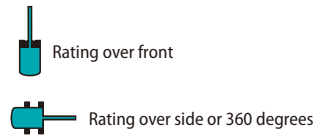
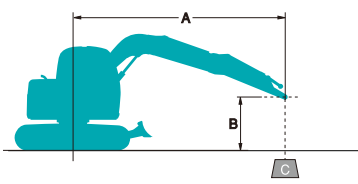

A: Reach from swing centreline to arm top
B: Arm top height above/below ground
C: Lifting capacities in Kilograms
Bucket: Without bucket
Relief valve setting: 29.4 MPa {300 kgf/cm²}

SK75SR		Offset Boom	Arm: 1.76 m	Bucket: Without	Counterweight: 1,050 kg	Shoe: 450 mm	Dozer: Blade up			
B	A	1.5 m		3.0 m		4.5 m		At max. reach		
										Radius
6.0 m	kg							*2,710	*2,710	2.73 m
4.5 m	kg			*2,460	*2,460			1,920	1,630	4.41 m
3.0 m	kg			*2,960	*2,960	1,780	1,510	1,380	1,160	5.17 m
1.5 m	kg			3,060	2,470	1,630	1,360	1,190	1,000	5.43 m
G.L.	kg			2,790	2,230	1,510	1,250	1,200	1,000	5.27 m
-1.5 m	kg	*3,750	*3,750	2,780	2,210	1,490	1,230	1,440	1,190	4.62 m
-3.0 m	kg			*1,460	*1,460			*1,320	*1,320	3.22 m

SK75SR		Offset Boom	Arm: 1.76 m	Bucket: Without	Counterweight: 1,050 kg + 300 kg	Shoe: 450 mm	Dozer: Blade up			
B	A	1.5 m		3.0 m		4.5 m		At max. reach		
										Radius
6.0 m	kg							*2,710	*2,710	2.73 m
4.5 m	kg			*2,460	*2,460			2,090	1,780	4.41 m
3.0 m	kg			*2,960	*2,960	1,950	1,660	1,520	1,290	5.17 m
1.5 m	kg			3,370	2,740	1,800	1,510	1,330	1,120	5.43 m
G.L.	kg			3,100	2,490	1,680	1,400	1,340	1,120	5.27 m
-1.5 m	kg	*3,750	*3,750	*2,990	2,480	1,670	1,390	1,610	1,340	4.62 m
-3.0 m	kg			*1,460	*1,460			*1,320	*1,320	3.22 m

SK75SR		Offset Boom	Arm: 2.06 m	Bucket: Without	Counterweight: 1,050 kg	Shoe: 450 mm	Dozer: Blade up			
B	A	1.5 m		3.0 m		4.5 m		At max. reach		
										Radius
6.0 m	kg			*2,370	*2,370			*2,340	*2,340	3.24 m
4.5 m	kg			*2,270	*2,270	1,900	1,620	1,710	1,450	4.74 m
3.0 m	kg	*5,000	*5,000	*2,770	*2,770	1,810	1,530	1,270	1,070	5.46 m
1.5 m	kg			3,130	2,530	1,640	1,370	1,100	920	5.70 m
G.L.	kg			2,790	2,220	1,500	1,240	1,100	910	5.54 m
-1.5 m	kg	*3,360	*3,360	2,730	2,170	1,460	1,200	1,290	1,060	4.94 m
-3.0 m	kg	*2,480	*2,480	*1,880	*1,880			*1,450	*1,450	3.66 m

SK75SR		Offset Boom	Arm: 2.06 m	Bucket: Without	Counterweight: 1,050 kg + 300 kg	Shoe: 450 mm	Dozer: Blade up			
B	A	1.5 m		3.0 m		4.5 m		At max. reach		
										Radius
6.0 m	kg			*2,370	*2,370			*2,340	*2,340	3.24 m
4.5 m	kg			*2,270	*2,270	*2,000	1,770	1,870	1,590	4.74 m
3.0 m	kg	*5,000	*5,000	*2,770	*2,770	1,980	1,690	1,400	1,190	5.46 m
1.5 m	kg			3,440	2,800	1,810	1,520	1,230	1,040	5.70 m
G.L.	kg			3,100	2,480	1,670	1,390	1,230	1,030	5.54 m
-1.5 m	kg	*3,360	*3,360	3,040	2,430	1,630	1,350	1,440	1,200	4.94 m
-3.0 m	kg	*2,480	*2,480	*1,880	*1,880			*1,450	*1,450	3.66 m

- Do not attempt to lift or hold any load that is greater than these lift capacities at their specified lift point radius and heights. Weight of all accessories must be deducted from the above lift capacities.
- Lift capacities are based on machine standing on level, firm, and uniform ground. User must make allowance for job conditions such as soft or uneven ground, out of level conditions, side loads, sudden stopping of loads, hazardous conditions, experience of personnel, etc.
- Arm top defined as lift point.
- The above lifting capacities are in compliance with ISO 10567. They do not exceed 87% of hydraulic lifting capacity or 75% of tipping load. Lifting capacities marked with an asterisk (*) are limited by hydraulic capacity rather than tipping load.
- Operator should be fully acquainted with the Operator's and Maintenance Instructions before operating this machine. Rules for safe operation of equipment should be adhered to at all times.
- Lift capacities apply to only machine as originally manufactured and normally equipped by KOBELCO CONSTRUCTION MACHINERY CO., LTD.

STANDARD EQUIPMENT

ENGINE

- YANMAR 4TNV98CT diesel engine with turbocharger and intercooler, EU Stage V compliant
- Auto Idle Stop
- Automatic engine deceleration
- Batteries (2 x 12 V - 81 Ah)
- Starting motor (24 V - 3.5 kW), 50 amp alternator
- Engine oil pan drain cock
- Double element air cleaner
- Refueling pump

CONTROL

- Working mode selector (H-mode, S-mode and ECO-mode)
- Rotating & N&B piping (proportional hand controlled) (for mono boom only)
- E & N&B piping (proportional hand controlled) (for 2 piece boom only)
- Bucket link with lifting hook (boom and arm safety valves and overload alarm)

SWING SYSTEM & TRAVEL SYSTEM

- Swing rebound prevention system
- Straight propel system
- Two-speed travel with automatic shift down
- Sealed & lubricated track links
- 450 mm steel shoes
- Grease-type track adjusters
- Automatic swing brake
- Lower frame guard
- Dozer blade

MIRRORS, LIGHTS & CAMERAS

- Rear view mirror, rear view camera and right side view camera
- LED work lights : 2 on boom, 1 on upper frame, 2 on rear counterweight

CAB & CONTROL

- Two control levers, pilot-operated
- Horn, electric
- Integrated left-right slide-type control box
- LED door light (interior)
- Coat hook
- Large cup holder
- Detachable two-piece floor mat
- GRAMMER* air suspension seat with heater
- Retractable seatbelt
- Headrest
- Handrails
- Intermittent Parallel wiper with double-spray washer
- Skylight
- Openable top guard (ISO 10262: 1998)
- Tinted safety glass
- Pull-type front window and removable lower front window
- Easy-to-read 10-inch LCD SCREEN multi-display monitor
- DAB+ radio (FM/AM & AUX & USB & Bluetooth* & hands free telephone)
- 12 V converter
- Hands-free telephone
- USB port
- Air conditioning system
The air conditioning system on this machine contains fluorinated greenhouse gas HFC-134a (GWP 1430).
Quantity of gas 0.8 kg (CO2 equivalent 1.2 t)
- Sun screen
- Large footrest

SAFETY

- Emergency escape hammer

OPTIONAL EQUIPMENT

- Various optional arms
- Wide range of shoes
- Front-guard protective structure (may interfere with bucket action)
- Additional counterweight (+300 kg)
- Cab top work LED lights (two lights)
- Mechanical suspension seat (Applicable for N&B piping)
- Rain visor (may interfere with bucket action)
- Floating dozer
- Low & High flow piping (proportional hand controlled) (for Offset boom only)
- Long Stroke Dozer
- Offset boom
- N&B piping (proportional hand controlled)
- Quick hitch piping
- Heavier counterweight (+350 kg)
- Eagle eye view
- Travel alarm

Note: Standard and optional equipment may vary. Consult your KOBELCO dealer for specifics.

Bluetooth* is a registered trademark of the Bluetooth SIG Inc.

*GRAMMER is trademark of GRAMMER AG. registered in Germany and other countries.

Note: This catalogue may contain attachments and optional equipment that are not available in your area. And it may contain photographs of machines with specifications that differ from those of machines sold in your areas. Please consult your nearest KOBELCO distributor for those items you require. Due to our policy of continuous product improvements all designs and specifications are subject to change without advance notice.

Copyright by **KOBELCO CONSTRUCTION MACHINERY CO., LTD.** No part of this catalogue may be reproduced in any manner without notice.

KOBELCO CONSTRUCTION MACHINERY EUROPE B.V.

Veluwezoom 15
1327 AE Almere
The Netherlands
www.kobelco-europe.com

Enquiries To: