

# KOBELCO

SK210LC-11E/ SK210NLC-11E/SK210SNLC-11E

Performance  Design

## SK210<sub>LC</sub>

## SK210<sub>NLC</sub>

## SK210<sub>SNLC</sub>

- Bucket capacity:  
0.45 – 0.80 m<sup>3</sup>
- Engine power:  
127 kW / 2,000 min<sup>-1</sup>
- Operating weight:  
22,100 – 24,600 kg



Complies with the EU Stage V  
exhaust emission regulation

*Built for Perfectionists*



# Performance X Design

SK210LC/SK210NLC/SK210SNLC of KOBELCO has realised a completely new value by harmonising PERFORMANCE and DESIGN.

Performance enhancements offer greater efficiency and productivity along with increased power and speed.

Design improvements provide the ultimate in comfort and control.

KOBELCO refuses to compromise, creating machines that meet every challenge.





# THE ULTIMATE IN SIMPLE DESIGN

In our pursuit of functional beauty and styling,  
we created an all new interior design focused with the operator in mind.

## Jog Dial

This dial integrates multiple functions into a single, easy to use interface. Even with gloves on, the operator can make the adjustments they need.

## LED Illumination

Dials and buttons are now backlit to provide a bright, clear view in any lighting condition.









# UNFORGETTABLE COMFORT

## Air suspension seat

A GRAMMER\* seat is installed as standard equipment, which achieves excellent shock absorption and superior ride comfort.

\*GRAMMER is trademark of GRAMMER AG, registered in Germany and other countries.

## Multi Vent Air Conditioner

Cool air is blown from multiple outlets toward the operator's body for more comfortable operation.

## Ergonomic Lever Angles

Operators can move levers horizontally without twisting their wrists, reducing fatigue.



## New Hydraulic Control

Our newly upgraded hydraulic control system responds to shorter lever strokes than previous models, delivering swifter, more precise movement and improved lever operability.

## LED Interior Light

Interior lights turn on and off automatically when the door is open or the ignition is turned to the OFF position. This ensures safe entry and exit in the dark.

## Parallel wipers secure a wide field of view



# KOBELCO



04:33



SETTING MENU



PICTURE OF CAMERA



CLOCK SETTING



SCREEN BRIGHTNESS



MAINTENANCE



CONSUMPTION



LANGUAGE SELECTION



PRESSURE RELEASE





# SAFETY ON FULL DISPLAY

## Standard 3 Sides Safety Camera System

Our high-resolution, large display shows right, left and rear side cameras together. Multiple display allows the operator to customize viewing needs to enhance operator awareness and jobsite safety.

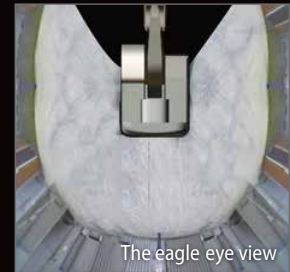
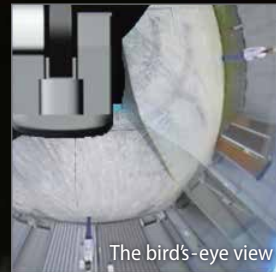
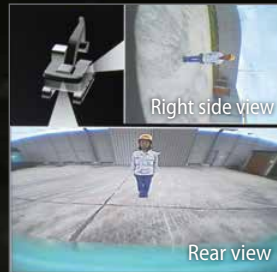
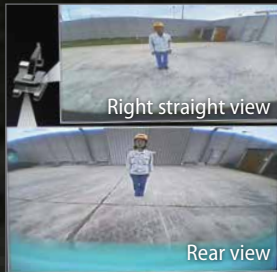

## Large 10-Inch Color Monitor

The easy-to-operate menu screen and recognizable icons assist the operator to select the most important information needed to ensure jobsite safety and machine control.



## Dial in the Right Information

Simply turn the jog dial to the right or left to select an operational feature, then press the dial to confirm selection.





### Independent Travel

Selecting Independent Travel dedicates one hydraulic pump to travel and one to the attachment on a continuous basis, allowing for a smooth and constant movement speed even while swinging or using the boom or attachment. With Independent Travel, safely carrying a large pipe across a job site is a breeze.

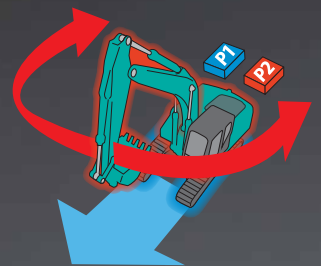

## EXPERIENCING A COMPETENT PERFORMANCE

### Higher Efficiency, plus a EU Stage V Compliant Engine

The new SK210LC/NLC/SNLC is equipped with a Yanmar Stage V compliant engine, which has a higher torque value. Superior balance between engine output and torque contributes to more efficient performance than the previous models. In addition, the DPF replacement interval has been extended.

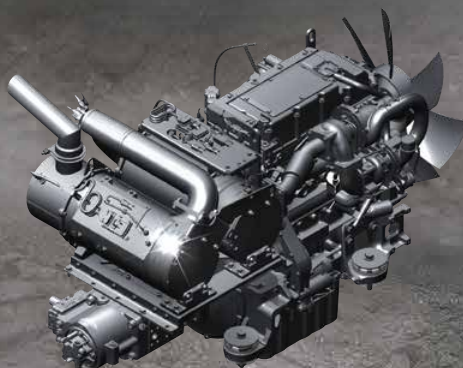

Model: YANMAR 4TN107FTT

Engine output

**127 kW / 2,000 min<sup>-1</sup>**





»» Max. bucket digging force (Arm 2.94 m)

Normal: **143** kN

With Power Boost: **157** kN

Lift capacity

**11,820** kg

(Reach: 4.50 m Boom: 5.65 m Arm: 2.94 m Bucket: Without Counterweight: 4,800 kg Shoe: 600 mm <Heavy Lift>)





# GREATER MULTI-FUNCTION CAPABILITIES

## Attachment mode selection

The auxiliary flow rates for the bucket, breaker, nibbler, and rotating are all now adjustable by the operator through the monitor, allowing you to change tools quickly and easily. Mode settings for other attachments like the tilt rotator can be added or changed.

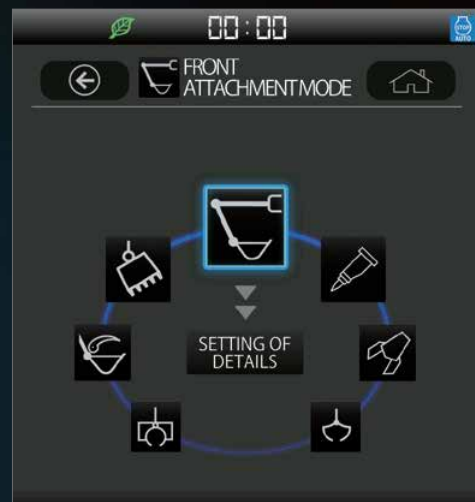

# EASY MAINTENANCE



## Standard Overhead Top Guard Level II

The standard overhead cab guard can be tilted open with gas damper for easy window cleaning. Meets standard top guard level II requirements. (ISO 10262)



## Engine Maintenance

Lower service platform makes engine service easier.



## Two-Stage Air Filter



## DEF/AdBlue<sup>®</sup> Tank

The DEF/AdBlue<sup>®</sup> fill is located inside the locking tool box.



## Left Side (Radiator and Cooling System Elements)

Laid out for easy access to radiator and cooling system.



## Right Side (Ground Level Maintenance)

Hydraulic pump and engine filter compartment.



## Fuel Filter / Pre-Filter with Integrated Water Separator



## Engine Oil Filter

Note: AdBlue<sup>®</sup> is a registered trademark of the Verband der Automobilindustrie e.V. (VDA).



# DURABILITY YOU CAN TRUST

## Enhanced body rigidity for 20-ton class machines

The SK210LC, SK210NLC and SK210SNLC machines are widely used in mid-scale construction projects and harsh worksites. The components have been reviewed and improvements have been made to their durability to ensure stable performance in such environments.



### Panels and supports

The right and left side panels and rear supports have been thicker to enhance body rigidity.



### Bucket cylinder rod pin

The increased diameter of the bucket cylinder rod pin contributes to enhanced durability for various types of attachments.



# CONVENIENT AND SENSIBLE EQUIPMENT



## Engine start password

A password is required when starting the engine for greater security.



## Wiper adjustment function

In addition to the intermittent wiper mode and continuous wiper mode, the one-time wiper mode was added.



## Parallel wipers

Sun screen



## Console mount

The console-integrated seat allows for comfortable operation.



## DAB+ radio (FM/AM & AUX & USB & Bluetooth® & hands-free telephone)



## USB port/12 V power outlet



## Smartphone holder

You can use the holder with your smartphone connected to the USB port.



# KOBELCO MONITORING EXCAVATOR SYSTEM

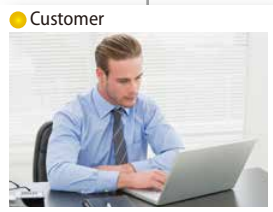

## Remote Monitoring for Peace of Mind

KOMEXS (Kobelco Monitoring Excavator System) uses satellite communication and internet to relay data, and therefore can be deployed in areas where other forms of communication are difficult. When a hydraulic excavator is fitted with this system, data on the machine's operation, such as operating hours, location, fuel consumption, and maintenance status can be obtained remotely.

## Direct Access to Operational Status

### Location Data

Accurate location data can be obtained even from sites where communications are difficult.

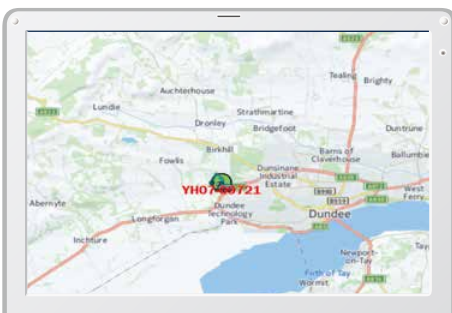

Latest location

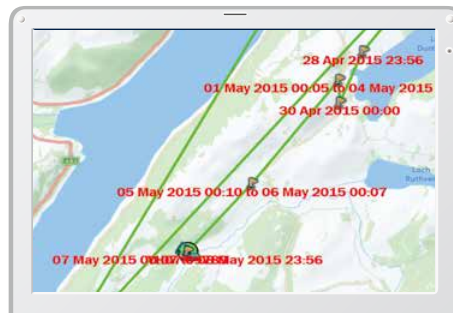

Location records

Period: 11 Apr, 2015 to 10 May, 2015		Search	
Type of Operation	Working Hrs		Ratio
Total Working Hrs	169 Hrs	100%	
Digging Hrs	72.2 Hrs	43%	
Traveling Hrs	18.3 Hrs	11%	
Idle Hrs	15.9 Hrs	9%	
Opt Att Hrs	62.5 Hrs	37%	
Crane Mode Hrs	0 Hrs	0%	

Work data

## Operating Hours

- A comparison of operating times of machines at multiple locations shows which locations are busier and more profitable.
- Operating hours on site can be accurately recorded, for running time calculations needed for rental machines, etc.

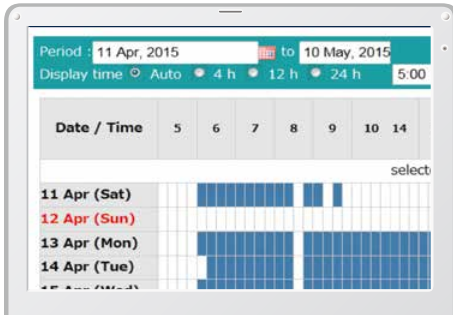

Daily report

## Fuel Consumption Data

Data on fuel consumption and idling times can be used to indicate improvements in fuel consumption.

Work mode	Working Hrs	Total Fuel Consumption
H mode	2:06	24.5 L
S mode	0:00	0.0 L
E mode	169:19	1489.7 L
<b>TOTAL</b>	<b>171:25</b>	<b>1514.2 L</b>

Fuel consumption

## Graph of Work Content

The graph shows how working hours are divided among different operating categories, including digging, idling, travelling and optional operations.



Work status

## Maintenance Data and Warning Alerts

### Machine Maintenance Data

- Provides maintenance status of separate machines operating at multiple sites.
- Maintenance data is also relayed to KOBELCO service personnel, for more efficient planning of periodic servicing.

Model	Serial No.	Hour Meter	Engine Oil
SK135SRLC-3/SK140SRL	<a href="#">YH07-09721</a>	734 Hr	434
SK135SRLC-3/SK140SRL	<a href="#">YH07-09789</a>	73 Hr	429
SK210LC-9	<a href="#">YQ13-10454</a>	960 Hr	58
SK210LC-9	<a href="#">YQ13-10481</a>	549 Hr	498
SK75SR-	<a href="#">YT08-30374</a>		

Maintenance

### Warning Alerts

This system warns an alert if an anomaly is sensed, preventing damage that could result in machine downtime.

## Alarm Information Can Be Received through E-mail

Alarm information or maintenance notice can be received through E-mail, using a computer or cell phone.



Alarm messages can be received on mobile device.

## Daily/Monthly Reports

Operational data downloaded onto a computer helps in formulating daily and monthly reports.

## Security System

### Engine Start Alarm

The system can be set an alarm if the machine is operated outside designated time.

Setting Condition

Setting Condition Change

Start time 20 : 00

Release time 07 : 00

No Working Whole Day

Mon Tue Wed Thu Fri Sat Sun

Clear

Engine start alarm outside prescribed work time

### Area Alarm

It can be set an alarm if the machine is moved out of its designated area to another location.

Setting Condition

Around the current (latest) location 1 Km

Input Latitude and Longitude

Latitude1

Longitude1

Latitude2

Longitude2

Map Clear

Release

Alarm for outside of reset area



# Specifications

## Engine

Model	YANMAR 4TN107FTT
Type	Four-cycle, water-cooled, direct injection diesel engine, turbo charged, EU Stage V exhaust emission regulation
No. of cylinders	4
Bore and stroke	107 mm × 127 mm
Displacement	4.567 L
Rated power output	122 kW / 2,000 min <sup>-1</sup> (ISO 9249 : with fan)
	127 kW / 2,000 min <sup>-1</sup> (ISO 14396: without fan)
Max. torque	791 N-m / 1,500 min <sup>-1</sup> (ISO 9249: with fan)
	805 N-m / 1,500 min <sup>-1</sup> (ISO 14396: without fan)

## Hydraulic system

Pump	
Type	Two variable displacement axial piston pumps + extra gear pump + pilot gear pump
Max. discharge flow	2 × 220 L/min, 1 × 40.6 L/min, 1 × 20 L/min
Relief valve setting	
Boom, arm and bucket	34.3 MPa
Power Boost*	37.8 MPa
Travel circuit	34.3 MPa
Swing circuit	29.0 MPa
Control circuit	5.0 MPa
Pilot control pump	Gear type
Main control valve	8-Spool valve
Oil cooler	Air cooled type

\*Not available for Long Reach

## Swing system

Swing motor	One fixed displacement piston motor
Brake	Hydraulic; locking automatically when the swing control lever is in the neutral position
Parking brake	Wet multiple plate
Swing speed	12.7 min <sup>-1</sup>
Swing torque	71.5 kN-m
Maximum swing gradient (Loaded)*	30 % {17 °}

\*Value for the least favourable specification

## Attachments

Backhoe bucket and combination

Use	Backhoe bucket				
	Normal digging				
Bucket capacity	ISO heaped	m <sup>3</sup>	0.45	0.70	0.80
Opening width	With side cutter	mm	910	1,080	1,160
	Without side cutter	mm	815	980	1,140
No. of teeth			5	5	5
Bucket weight		kg	360	630	660
Combination	2.40 m short arm		—	○	○
	2.94 m standard arm		—	○	◎
	3.50 m long arm		—	◎	△
	6.35m arm (Long Reach)		◎	—	—

◎ Standard ○ Recommended △ Loading only

## Travel system

Travel motors	2 × axial-piston, two-step motors
Travel brakes	Hydraulic brake per motor
Parking brakes	Oil disc brake per motor
Travel shoes	49 each side
Travel speed	6.0/3.6 km/h
Rated drawbar pull	228 kN (SAE J 1309)
Gradeability	70% {35°}

## Cab & control

### Cab

All-weather, sound-suppressed steel cab mounted on the high suspension mounts filled with silicone oil and equipped with a heavy, insulated floor mat.

### Control

Two hand levers and two foot pedals for travel

Two hand levers for excavating and swing

Electric rotary-type engine throttle

### Noise levels

External 103 dB(A) (2000/14/EC)

Operator 71 dB(A) (ISO 6396)

### Vibration levels

Hand/arm\* ≤ 2.5 m/s<sup>2</sup>

Body\* ≤ 0.5 m/s<sup>2</sup>

\*For the risk assessment according to 2002/44/EC, refer to ISO/TR 25398: 2006

## Cylinders

Boom cylinders	120 mm × 1,355 mm
Arm cylinder (Long Reach)	135 mm × 1,558 mm (135 mm × 1,489 mm)
Bucket cylinder (Long Reach)	120 mm × 1,080 mm (95 mm × 885 mm)
Jib cylinder*	150 mm × 992 mm

\*For 2 Piece boom only

## Refilling capacities & lubrications

Fuel tank	321 L
Cooling system	23 L
Engine oil	20 L
Travel reduction gear	2 × 5.3 L
Swing reduction gear	1 × 2.7 L
Hydraulic oil tank	140 L tank oil level
	244 L hydraulic system
DEF/ Urea tank	SK210LC/NLC 83 L
	SK210SNLC 34 L

# SK210<sup>LC</sup>

SK210LC-11E

# SK210<sup>NLC</sup>

SK210NLC-11E

# SK210<sup>SNLC</sup>

SK210SNLC-11E



## Working ranges

Unit: mm

Boom	5.65 m		
Range	Short 2.40 m	Standard 2.94 m	Long 3.50 m
a- Max. digging reach	9,420	9,900	10,340
b- Max. digging reach at ground level	9,240	9,730	10,170
c- Max. digging depth	6,160	6,700	7,260
d- Max. digging height	9,510	9,720	9,750
e- Max. dumping clearance	6,680	6,910	6,970
f- Min. dumping clearance	2,980	2,430	1,870
g- Max. vertical wall digging depth	5,570	6,100	6,470
h- Min. swing radius	3,560	3,550	3,480
i- Horizontal digging stroke at ground level	4,080	5,270	6,080
j- Digging depth for 2.4 m (8') flat bottom	5,950	6,520	7,080
Bucket capacity ISO heaped m <sup>3</sup>	0.93	0.80	0.70

## Digging Force (ISO 6015)

Unit: kN

Arm length	Short 2.40 m	Standard 2.94 m	Long 3.50 m
Bucket digging force	143 157*	143 157*	143 157*
Arm crowding force	121 133*	102 112*	91.8 101*

\*Power boost engaged

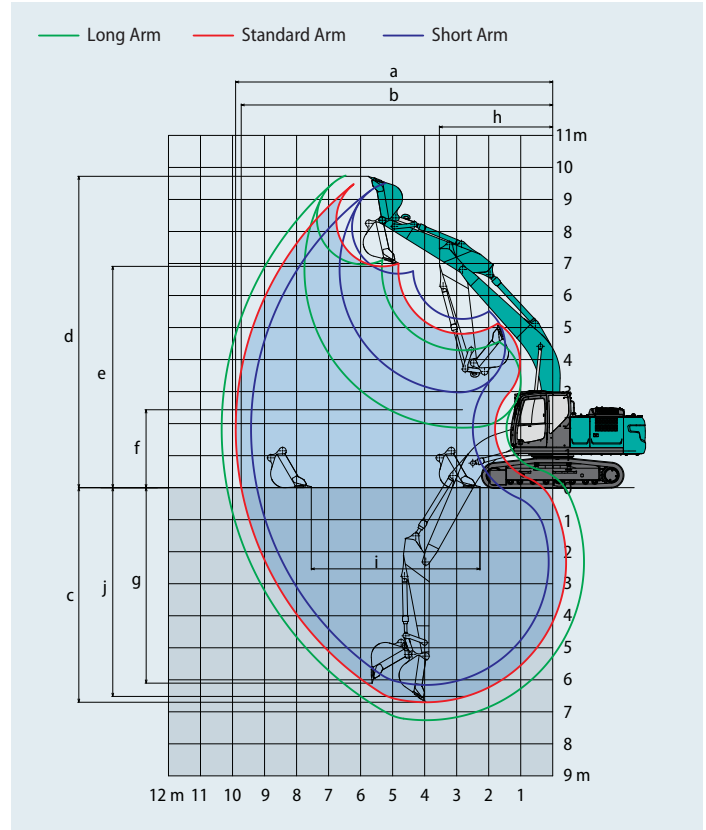

## Dimensions (SK210LC/SK210NLC)

Unit: mm

Arm length	Short 2.40 m	Standard 2.94 m	Long 3.50 m
A Overall length	9,680	9,600	9,670
B Overall height (to top of boom)	3,200	3,030	3,210
C Overall width of crawler	SK210LC	2,990	
	SK210NLC	2,800	
D Overall height (to top of cab)		3,060	
E Ground clearance of rear end*		1,060	
F Ground clearance*		425	
G Tail swing radius		2,910	
G' Distance from centre of swing to rear end		2,900	
H Tumbler distance		3,660	
I Overall length of crawler		4,450	
J Track gauge	SK210LC	2,390	
	SK210NLC	2,200	
K Shoe width		600	
L Overall width of upperstructure		2,710	

\*Without including height of shoe



## Dimensions (SK210SNLC)

Unit: mm

Arm length	Short 2.40 m	Standard 2.94 m
A Overall length	9,580	9,500
B Overall height (to top of boom)	3,200	3,030
C Overall width of crawler	2,540	
D Overall height (to top of cab)	3,060	
E Ground clearance of rear end*	1,050	
F Ground clearance*	425	
G Tail swing radius	2,800	
G' Distance from centre of swing to rear end	2,800	
H Tumbler distance	3,660	
I Overall length of crawler	4,450	
J Track gauge	2,040	
K Shoe width	500	
L Overall width of upperstructure	2,540	

\*Without including height of shoe

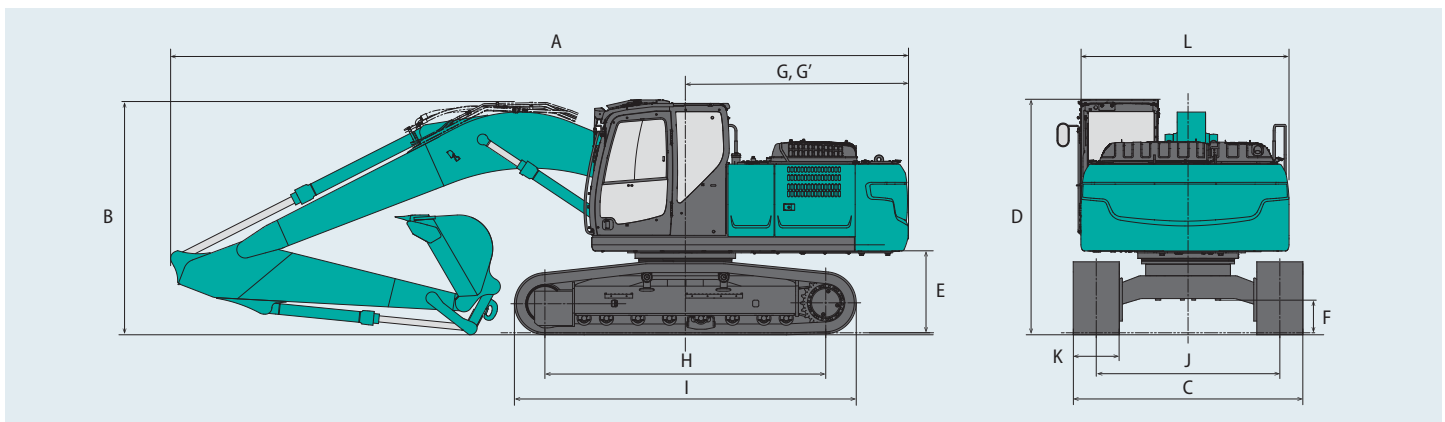



# Operating weight & ground pressure

In standard trim, with standard boom, 2.94 m arm, and 0.8 m³ ISO heaped bucket.

Shaped			Triple grouser shoes (even height)				
Shoe width		mm	500	600	700	790	900
Overall width of crawler	SK210LC	mm	—	2,990	3,090	3,180	3,290
	SK210NLC	mm	—	2,800	2,900	2,990	—
	SK210SNLC	mm	2,540	2,640	—	—	—
Ground pressure	SK210LC	kPa	—	46	40	36	32
	SK210NLC	kPa	—	46	40	36	—
	SK210SNLC	kPa	56	47	—	—	—
Operating weight	SK210LC	kg	—	22,100	22,500	22,700	23,100
	SK210NLC	kg	—	22,000	22,500	22,700	—
	SK210SNLC	kg	22,500	22,700	—	—	—

In standard trim, with standard boom, 2.94 m arm, and 0.8 m³ ISO heaped bucket (optional counterweight 4,800 kg).

Shaped			Triple grouser shoes (even height)			
Shoe width		mm	600	700	790	900
Overall width of crawler	SK210LC	mm	2,990	3,090	3,180	3,290
	SK210NLC	mm	2,800	2,900	2,990	—
Ground pressure	SK210LC	kPa	47	41	37	33
	SK210NLC	kPa	47	41	37	—
Operating weight	SK210LC	kg	22,600	23,100	23,300	23,600
	SK210NLC	kg	22,500	23,000	23,200	—

## Lift capacities

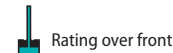
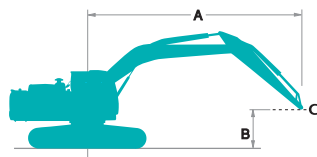

A - Reach from swing centerline to arm top

B - Arm top height above/below ground

C - Lift point

Relief valve setting: 37.8 MPa

SK210LC		Boom: 5.65 m		Arm: 2.94 m		Bucket: without		Counterweight: 4,300 kg		Shoe: 600 mm (Heavy Lift)				
B	A	1.5 m		3.0 m		4.5 m		6.0 m		7.5 m		At max. reach		
		Rating over front	Rating over side or 360 degrees	Rating over front	Rating over side or 360 degrees	Rating over front	Rating over side or 360 degrees	Rating over front	Rating over side or 360 degrees	Rating over front	Rating over side or 360 degrees	Rating over front	Rating over side or 360 degrees	Radius
7.5 m	kg							*5,300	*5,300			*4,270	*4,270	6.26 m
6.0 m	kg							*5,880	5,480			*3,940	3,850	7.36 m
4.5 m	kg							*6,420	5,280	5,680	3,680	*3,860	3,270	8.03 m
3.0 m	kg					*9,360	7,670	*7,270	5,000	5,540	3,560	*3,930	2,980	8.38 m
1.5 m	kg					*11,040	7,100	7,570	4,720	5,400	3,430	*4,170	2,870	8.45 m
G.L.	kg			*6,330	*6,330	11,660	6,790	7,360	4,530	5,290	3,330	*4,600	2,920	8.25 m
-1.5 m	kg	*6,700	*6,700	*11,060	*11,060	11,560	6,700	7,270	4,460	5,260	3,310	5,030	3,170	7.75 m
-3.0 m	kg	*11,730	*11,730	*14,650	13,240	*10,550	6,780	7,320	4,510			6,010	3,770	6.89 m
-4.5 m	kg			*10,860	*10,860	*7,950	7,050					*5,980	5,330	5.50 m

SK210LC		Boom: 5.65 m		Arm: 3.50 m		Bucket: without		Counterweight: 4,300 kg		Shoe: 600 mm (Heavy Lift)				
B	A	1.5 m		3.0 m		4.5 m		6.0 m		7.5 m		At max. reach		
		Rating over front	Rating over side or 360 degrees	Rating over front	Rating over side or 360 degrees	Rating over front	Rating over side or 360 degrees	Rating over front	Rating over side or 360 degrees	Rating over front	Rating over side or 360 degrees	Rating over front	Rating over side or 360 degrees	Radius
7.5 m	kg											*3,640	*3,640	6.84 m
6.0 m	kg									*4,540	3,790	*3,430	*3,430	7.86 m
4.5 m	kg							*5,840	5,350	*5,440	3,710	*3,400	2,970	8.49 m
3.0 m	kg			*12,860	*12,860	*8,480	7,840	*6,750	5,050	5,550	3,560	*3,490	2,720	8.82 m
1.5 m	kg			*7,240	*7,240	*10,380	7,190	7,600	4,740	5,380	3,410	*3,710	2,610	8.89 m
G.L.	kg			*7,730	*7,730	*11,520	6,770	7,330	4,500	5,240	3,280	*4,110	2,650	8.70 m
-1.5 m	kg	*6,570	*6,570	*10,960	*10,960	11,470	6,610	7,190	4,380	5,170	3,220	4,540	2,840	8.22 m
-3.0 m	kg	*10,480	*10,480	*15,820	12,950	*11,000	6,630	7,190	4,380			5,290	3,300	7.42 m
-4.5 m	kg	*15,580	*15,580	*12,690	*12,690	*9,090	6,820	*6,410	4,540			*6,100	4,390	6.16 m

# SK210<sup>LC</sup>

SK210LC-11E

# SK210<sup>NLC</sup>

SK210NLC-11E

# SK210<sup>SNLC</sup>

SK210SNLC-11E

SK210LC		Boom: 5.65 m Arm: 2.40 m Bucket: without Counterweight: 4,300 kg Shoe: 600 mm (Heavy Lift)											
B	A	3.0 m		4.5 m		6.0 m		7.5 m		At max. reach		Radius	
7.5 m	kg										*6,320	6,030	5.58 m
6.0 m	kg					*6,470	5,380				*5,760	4,340	6.80 m
4.5 m	kg			*8,260	8,130	*6,930	5,210	5,620	3,630		5,590	3,610	7.52 m
3.0 m	kg			*10,100	7,490	*7,700	4,940	5,520	3,540		5,090	3,270	7.89 m
1.5 m	kg			*11,520	6,990	*7,530	4,700	5,400	3,440		4,940	3,150	7.97 m
G.L.	kg			11,640	6,780	7,360	4,540	5,330	3,370		5,090	3,230	7.75 m
-1.5 m	kg	*11,440	*11,440	*11,390	6,760	7,320	4,510				5,630	3,560	7.22 m
-3.0 m	kg	*13,150	*13,150	*9,880	6,900	*7,190	4,630				*6,580	4,370	6.29 m
-4.5 m	kg			*6,230	*6,230						*5,690	*5,690	4.72 m

SK210LC		Boom: 5.65 m Arm: 2.94 m Bucket: without Counterweight: 4,800 kg Shoe: 600 mm (Heavy Lift)												
B	A	1.5 m		3.0 m		4.5 m		6.0 m		7.5 m		At max. reach		Radius
7.5 m	kg							*5,300	*5,300			*4,270	*4,270	6.26 m
6.0 m	kg							*5,880	5,840			*3,940	*3,940	7.36 m
4.5 m	kg							*6,420	5,640	*5,910	3,960	*3,860	3,520	8.03 m
3.0 m	kg					*9,360	8,200	*7,270	5,360	5,890	3,840	*3,930	3,210	8.38 m
1.5 m	kg					*11,040	7,620	8,040	5,090	5,740	3,700	*4,170	3,110	8.45 m
G.L.	kg			*6,330	*6,330	*11,820	7,310	7,820	4,890	5,630	3,600	*4,600	3,170	8.25 m
-1.5 m	kg	*6,700	*6,700	*11,060	*11,060	*11,650	7,230	7,740	4,820	5,610	3,580	5,360	3,440	7.75 m
-3.0 m	kg	*11,730	*11,730	*14,650	14,230	*10,550	7,310	7,790	4,870			*6,330	4,080	6.89 m
-4.5 m	kg			*10,860	*10,860	*7,950	7,570					*5,980	5,730	5.50 m

SK210LC		Boom: 5.65 m Arm: 3.50 m Bucket: without Counterweight: 4,800 kg Shoe: 600 mm (Heavy Lift)														
B	A	1.5 m		3.0 m		4.5 m		6.0 m		7.5 m		At max. reach		Radius		
7.5 m	kg											*3,640	*3,640	6.84 m		
6.0 m	kg											*4,540	4,060	*3,430	*3,430	7.86 m
4.5 m	kg							*5,840	5,710	*5,440	3,980	*3,400	3,210	8.49 m		
3.0 m	kg			*12,860	*12,860	*8,480	8,370	*6,750	5,410	*5,860	3,840	*3,490	2,940	8.82 m		
1.5 m	kg			*7,240	*7,240	*10,380	7,720	*7,700	5,100	5,720	3,680	*3,710	2,840	8.89 m		
G.L.	kg			*7,730	*7,730	*11,520	7,300	7,800	4,860	5,590	3,550	*4,110	2,880	8.70 m		
-1.5 m	kg	*6,570	*6,570	*10,960	*10,960	*11,710	7,140	7,660	4,740	5,200	3,490	*4,820	3,080	8.22 m		
-3.0 m	kg	*10,480	*10,480	*15,820	13,940	*11,000	7,160	7,660	4,740			5,640	3,580	7.42 m		
-4.5 m	kg	*15,580	*15,580	*12,690	*12,690	*9,090	7,350	*6,410	4,900			*6,100	4,740	6.16 m		

SK210LC		Boom: 5.65 m Arm: 2.40 m Bucket: without Counterweight: 4,800 kg Shoe: 600 mm (Heavy Lift)											
B	A	3.0 m		4.5 m		6.0 m		7.5 m		At max. reach		Radius	
7.5 m	kg										*6,320	*6,320	5.58 m
6.0 m	kg					*6,470	5,740				*5,760	4,650	6.80 m
4.5 m	kg			*8,260	*8,260	*6,930	5,570	*5,850	3,910		*5,610	3,880	7.52 m
3.0 m	kg			*10,100	8,020	*7,700	5,300	5,860	3,820		5,410	3,520	7.89 m
1.5 m	kg			*11,520	7,520	8,000	5,060	5,740	3,710		5,250	3,400	7.97 m
G.L.	kg			*11,920	7,310	7,830	4,900	5,670	3,640		5,420	3,490	7.75 m
-1.5 m	kg	*11,440	*11,440	*11,390	7,290	7,790	4,870				6,000	3,840	7.22 m
-3.0 m	kg	*13,150	*13,150	*9,880	7,430	*7,190	4,990				*6,580	4,710	6.29 m
-4.5 m	kg			*6,230	*6,230						*5,690	*5,690	4.72 m













**Notes:**













- Do not attempt to lift or hold any load that is greater than these lift capacities at their specified lift point radius and heights. Weight of all accessories must be deducted from the above lift capacities.
- Lift capacities are based on machine standing on level, firm, and uniform ground. User must make allowance for job conditions such as soft or uneven ground, out of level conditions, side loads, sudden stopping of loads, hazardous conditions, experience of personnel, etc.
- Arm top defined as lift point.
- The above lift capacities are in compliance with ISO 10567. They do not exceed 87% of hydraulic lift













capacity or 75% of tipping load. Lift capacities marked with an asterisk (\*) are limited by hydraulic capacity rather than tipping load.













- Operator should be fully acquainted with the Operator's and Maintenance Instructions before operating this machine. Rules for safe operation of equipment should be adhered to at all times.
- Lift capacities apply to only machine as originally manufactured and normally equipped by KOBELCO CONSTRUCTION MACHINERY CO., LTD.



SK210NLC		Boom: 5.65 m		Arm: 2.94 m		Bucket: without		Counterweight: 4,300 kg		Shoe: 600 mm (Heavy Lift)					
B	A	1.5 m		3.0 m		4.5 m		6.0 m		7.5 m		At max. reach			
														Radius	
7.5 m	kg							*5,300	5,060			*4,270	*4,270	6.26 m	
6.0 m	kg							*5,880	5,050			*3,940	3,540	7.36 m	
4.5 m	kg							*6,420	4,850	5,670	3,380	*3,860	2,990	8.03 m	
3.0 m	kg						*9,360	6,980	*7,270	4,580	5,530	3,260	*3,930	2,720	8.38 m
1.5 m	kg						*11,040	6,420	7,560	4,310	5,390	3,130	*4,170	2,620	8.45 m
G.L.	kg			*6,330	*6,330	11,630	6,120	7,340	4,120	5,280	3,030	*4,600	2,660	8.25 m	
-1.5 m	kg	*6,700	*6,700	*11,060	*11,060	11,530	6,040	7,250	4,040	5,250	3,010	5,020	2,890	7.75 m	
-3.0 m	kg	*11,730	*11,730	*14,650	11,700	*10,550	6,120	7,310	4,090			6,000	3,440	6.89 m	
-4.5 m	kg			*10,860	*10,860	*7,950	6,370					*5,980	4,850	5.50 m	

SK210NLC		Boom: 5.65 m		Arm: 3.50 m		Bucket: without		Counterweight: 4,300 kg		Shoe: 600 mm (Heavy Lift)				
B	A	1.5 m		3.0 m		4.5 m		6.0 m		7.5 m		At max. reach		
														Radius
7.5 m	kg											*3,640	*3,640	6.84 m
6.0 m	kg									*4,540	3,480	*3,430	3,180	7.86 m
4.5 m	kg							*5,480	4,920	*5,440	3,400	*3,400	2,720	8.49 m
3.0 m	kg			*12,860	*12,860	*8,480	7,140	*6,750	4,620	5,540	3,260	*3,490	2,480	8.82 m
1.5 m	kg			*7,240	*7,240	*10,380	6,510	7,580	4,320	5,370	3,110	*3,710	2,380	8.89 m
G.L.	kg			*7,730	*7,730	*11,520	6,110	7,310	4,090	5,230	2,980	*4,110	2,400	8.70 m
-1.5 m	kg	*6,570	*6,570	*10,960	*10,960	11,440	5,950	7,180	3,970	5,160	2,920	4,530	2,580	8.22 m
-3.0 m	kg	*10,480	*10,480	*15,820	11,410	*11,000	5,970	7,170	3,970			5,280	3,000	7.42 m
-4.5 m	kg	*15,580	*15,580	*12,690	11,780	*9,090	6,150	*6,410	4,130			*6,100	3,990	6.16 m

SK210NLC		Boom: 5.65 m		Arm: 2.40 m		Bucket: without		Counterweight: 4,300 kg		Shoe: 600 mm (Heavy Lift)				
B	A	3.0 m		4.5 m		6.0 m		7.5 m		At max. reach		Radius		
														Radius
7.5 m	kg											*6,320	5,550	5.58 m
6.0 m	kg							*6,470	4,960			*5,760	3,990	6.80 m
4.5 m	kg			*8,260	7,430	*6,930	4,780	4,780	5,600	3,330		5,570	3,310	7.52 m
3.0 m	kg			*10,100	6,810	*7,700	4,520	4,520	5,510	3,250		5,070	2,990	7.89 m
1.5 m	kg			*11,520	6,320	7,520	4,280	4,280	5,390	3,140		4,920	2,870	7.97 m
G.L.	kg			11,610	6,110	7,350	4,130	4,130	5,310	3,070		5,070	2,940	7.75 m
-1.5 m	kg	*11,440	*11,440	*11,390	6,100	7,310	4,100	4,100				5,620	3,240	7.22 m
-3.0 m	kg	*13,150	11,920	*9,880	6,240	*7,190	4,210	4,210				*6,580	3,990	6.29 m
-4.5 m	kg			*6,230	*6,230							*5,690	*5,690	4.72 m

SK210NLC		Boom: 5.65 m		Arm: 2.94 m		Bucket: without		Counterweight: 4,800 kg		Shoe: 600 mm (Heavy Lift)				
B	A	1.5 m		3.0 m		4.5 m		6.0 m		7.5 m		At max. reach		
														Radius
7.5 m	kg							*5,300	*5,300			*4,270	*4,270	6.26 m
6.0 m	kg							*5,880	5,390			*3,940	3,810	7.36 m
4.5 m	kg							*6,420	5,200	*5,910	3,650	*3,860	3,240	8.03 m
3.0 m	kg					*9,360	7,480	*7,270	4,920	5,880	3,530	*3,930	2,950	8.38 m
1.5 m	kg					*11,040	6,920	8,020	4,650	5,730	3,390	*4,170	2,840	8.45 m
G.L.	kg			*6,330	*6,330	*11,820	6,620	7,810	4,470	5,620	3,300	*4,600	2,900	8.25 m
-1.5 m	kg	*6,700	*6,700	*11,060	*11,060	*11,650	6,540	7,720	4,390	5,600	3,270	5,350	3,140	7.75 m
-3.0 m	kg	*11,730	*11,730	*14,650	12,610	*10,550	6,620	7,780	4,440			*6,330	3,730	6.89 m
-4.5 m	kg			*10,860	*10,860	*7,950	6,870					*5,980	5,230	5.50 m

# SK210<sup>LC</sup>













SK210LC-11E











# SK210<sup>NLC</sup>













SK210NLC-11E











# SK210<sup>SNLC</sup>

SK210SNLC-11E

SK210NLC		Boom: 5.65 m Arm: 3.50 m Bucket: without Counterweight: 4,800 kg Shoe: 600 mm (Heavy Lift)												
B \ A	1.5 m		3.0 m		4.5 m		6.0 m		7.5 m		At max. reach		Radius	
														
7.5 m	kg											*3,640	*3,640	6.84 m
6.0 m	kg									*4,540	3,740	*3,430	3,430	7.86 m
4.5 m	kg							*5,840	5,260	*5,440	3,670	*3,400	2,950	8.49 m
3.0 m	kg			*12,860	*12,860	*8,480	7,640	*6,750	4,970	*5,860	3,520	*3,490	2,700	8.82 m
1.5 m	kg			*7,240	*7,240	*10,380	7,010	*7,700	4,660	*5,710	3,370	*3,710	2,590	8.89 m
G.L.	kg			*7,730	*7,730	*11,520	6,610	7,780	4,430	5,570	3,240	*4,110	2,620	8.70 m
-1.5 m	kg	*6,570	*6,570	*10,960	*10,960	*11,710	6,450	7,640	4,310	5,500	3,180	*4,820	2,810	8.22 m
-3.0 m	kg	*10,480	*10,480	*15,820	12,330	*11,000	6,470	7,640	4,310			5,620	3,260	7.42 m
-4.5 m	kg	*15,580	*15,580	*12,690	*12,690	*9,090	6,650	*6,410	4,470			*6,100	4,320	6.16 m

SK210NLC		Boom: 5.65 m Arm: 2.40 m Bucket: without Counterweight: 4,800 kg Shoe: 600 mm (Heavy Lift)												
B \ A	3.0 m		4.5 m		6.0 m		7.5 m		At max. reach		Radius			
														
7.5 m	kg											*6,320	5,920	5.58 m
6.0 m	kg					*6,470	5,300					*5,760	4,280	6.80 m
4.5 m	kg			*8,260	7,930	*6,930	5,130	*5,850	3,600	*5,610		3,570		7.52 m
3.0 m	kg			*10,100	7,310	*7,700	4,870	5,850	3,510	5,400		3,240		7.89 m
1.5 m	kg			*11,520	6,820	7,990	4,630	5,730	3,400	5,240		3,120		7.97 m
G.L.	kg			*11,920	6,620	7,810	4,480	5,660	3,330	5,400		3,200		7.75 m
-1.5 m	kg	*11,440	*11,440	*11,390	6,600	7,780	4,440			5,980		3,520		7.22 m
-3.0 m	kg	*13,150	12,830	*9,880	6,740	*7,190	4,560			*6,580		4,310		6.29 m
-4.5 m	kg			*6,230	*6,230					*5,690		*5,690		4.72 m

SK210SNLC		Boom: 5.65 m Arm: 2.94 m Bucket: without Counterweight: 4,900 kg Shoe: 500 mm (Heavy Lift)												
B \ A	1.5 m		3.0 m		4.5 m		6.0 m		7.5 m		At max. reach		Radius	
														
7.5 m	kg							*5,330	5,060			*4,300	*4,300	6.26 m
6.0 m	kg							*5,940	5,050			*3,980	3,580	7.36 m
4.5 m	kg							*6,490	4,870	*5,980	3,430	*3,890	3,050	8.03 m
3.0 m	kg					*9,450	6,950	*7,360	4,610	5,880	3,320	*3,970	2,780	8.38 m
1.5 m	kg					*11,150	6,430	8,030	4,350	5,740	3,190	*4,200	2,680	8.45 m
G.L.	kg			*6,370	*6,370	*11,940	6,140	7,820	4,180	5,640	3,100	*4,640	2,730	8.25 m
-1.5 m	kg	*6,730	*6,730	*11,090	*11,090	*11,770	6,060	7,730	4,100	5,610	3,070	5,370	2,950	7.75 m
-3.0 m	kg	*11,760	*11,760	*14,800	11,460	*10,660	6,140	7,780	4,150			6,400	3,500	6.89 m
-4.5 m	kg			*11,000	*11,000	*8,060	6,370					*6,070	4,880	5.50 m

SK210SNLC		Boom: 5.65 m Arm: 2.40 m Bucket: without Counterweight: 4,900 kg Shoe: 500 mm (Heavy Lift)												
B \ A	3.0 m		4.5 m		6.0 m		7.5 m		At max. reach		Radius			
														
7.5 m	kg											*6,370	5,570	5.58 m
6.0 m	kg					*6,570	4,990					*5,800	4,050	6.80 m
4.5 m	kg			*8,380	7,400	*7,030	4,830	*5,890	3,410	*5,650		3,390		7.52 m
3.0 m	kg			*10,230	6,830	*7,820	4,590	5,890	3,330	5,430		3,070		7.89 m
1.5 m	kg			*11,680	6,370	8,020	4,360	5,770	3,220	5,280		2,960		7.97 m
G.L.	kg			*12,080	6,180	7,860	4,220	5,700	3,160	5,440		3,030		7.75 m
-1.5 m	kg	*11,480	*11,480	*11,550	6,160	7,820	4,190			6,020		3,330		7.22 m
-3.0 m	kg	*13,350	11,720	*10,030	6,290	*7,310	4,290			*6,700		4,060		6.29 m
-4.5 m	kg			*6,360	*6,360					*5,820		*5,820		4.72 m

### Notes:

- Do not attempt to lift or hold any load that is greater than these lift capacities at their specified lift point radius and heights. Weight of all accessories must be deducted from the above lift capacities.
- Lift capacities are based on machine standing on level, firm, and uniform ground. User must make allowance for job conditions such as soft or uneven ground, out of level conditions, side loads, sudden stopping of loads, hazardous conditions, experience of personnel, etc.
- Arm top defined as lift point.
- The above lift capacities are in compliance with ISO 10567. They do not exceed 87% of hydraulic lift capacity or 75% of tipping load. Lift capacities marked with an asterisk (\*) are limited by hydraulic capacity rather than tipping load.
- Operator should be fully acquainted with the Operator's and Maintenance Instructions before operating this machine. Rules for safe operation of equipment should be adhered to at all times.
- Lift capacities apply to only machine as originally manufactured and normally equipped by KOBELCO CONSTRUCTION MACHINERY CO., LTD.



## 2 Piece Boom Specifications



### Working ranges

Unit: mm

Boom	Arm	2 Piece boom		
		Short 2.40 m	Standard 2.94 m	Long 3.50 m
a- Max. digging reach		9,570	10,070	10,530
b- Max. digging reach at ground level		9,390	9,900	10,370
c- Max. digging depth		5,890	6,420	6,930
d- Max. digging height		10,830	11,230	11,500
e- Max. dumping clearance		7,950	8,350	8,620
f- Min. dumping clearance		1,510	970	410
g- Max. vertical wall digging depth		5,070	5,580	6,020
h- Min. swing radius		2,760	2,550	2,720
i- Horizontal digging stroke at ground level		5,770	6,800	7,800
j- Digging depth for 2.4 m (8') flat bottom		5,780	6,310	6,830
Bucket capacity ISO heaped m <sup>3</sup>		0.93	0.80	0.70

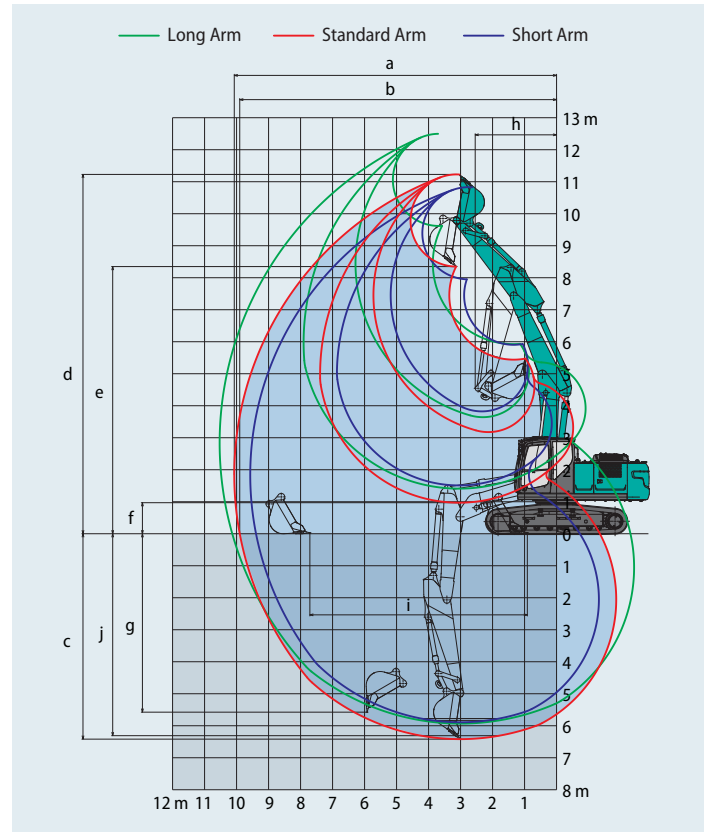

### Digging Force (ISO 6015)

Unit: kN

Arm length	Short 2.40 m	Standard 2.94 m	Long 3.50 m
Bucket digging force	143 157*	143 157*	143 157*
Arm crowding force	121 133*	102 112*	91.8 101*

\*Power Boost engaged.



### Dimensions (SK210LC/SK210NLC)

Unit: mm

Arm length	Short 2.40 m	Standard 2.94 m	Long 3.50 m
A Overall length	9,760	9,740	9,730
B Overall height (to top of boom)	3,030	2,970	3,280
C Overall width of crawler	SK210LC	2,990	
	SK210NLC	2,800	
D Overall height (to top of cab)	3,060		
E Ground clearance of rear end*	1,060		
F Ground clearance*	425		
G Tail swing radius	2,910		
G' Distance from centre of swing to rear end	2,900		
H Tumbler distance	3,660		
I Overall length of crawler	4,450		
J Track gauge	SK210LC	2,390	
	SK210NLC	2,200	
K Shoe width	600		
L Overall width of upperstructure	2,710		

\*Without including height of shoe



### Dimensions (SK210SNLC)

Unit: mm

Arm length	Short 2.40 m	Standard 2.94 m
A Overall length	9,660	9,640
B Overall height (to top of boom)	3,030	2,970
C Overall width of crawler	2,540	
D Overall height (to top of cab)	3,060	
E Ground clearance of rear end*	1,050	
F Ground clearance*	425	
G Tail swing radius	2,800	
G' Distance from centre of swing to rear end	2,800	
H Tumbler distance	3,660	
I Overall length of crawler	4,450	
J Track gauge	2,040	
K Shoe width	500	
L Overall width of upperstructure	2,540	

\*Without including height of shoe

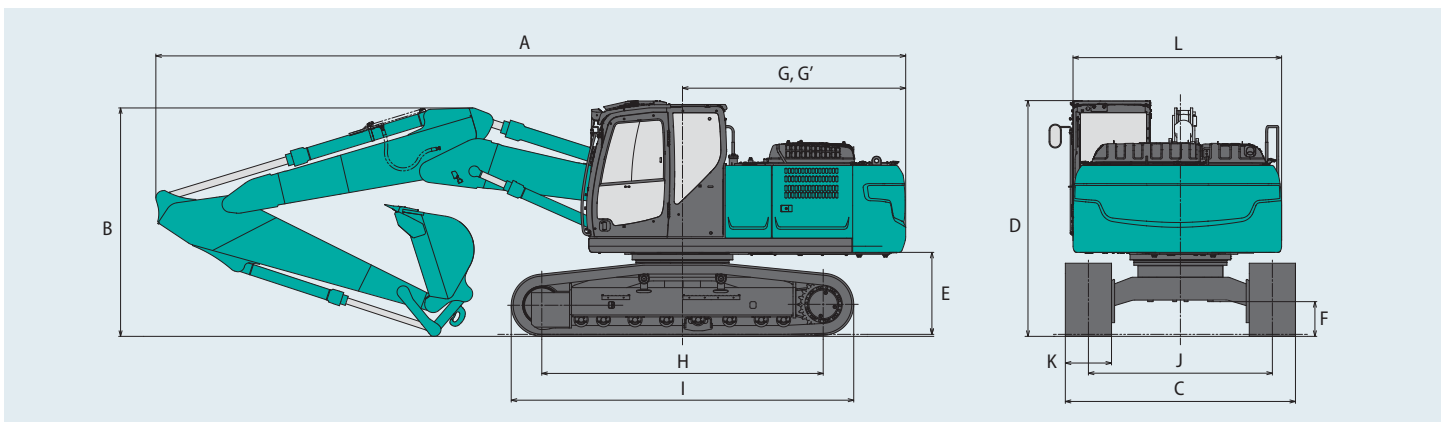

## Operating weight & ground pressure

In standard trim, with 2 Piece boom, 2.94 m arm, and 0.8 m<sup>3</sup> ISO heaped bucket.

Shaped			Triple grouser shoes (even height)				
Shoe width		mm	500	600	700	790	900
Overall width of crawler	SK210LC	mm	—	2,990	3,090	3,180	3,290
	SK210NLC	mm	—	2,800	2,900	2,990	—
	SK210SNLC	mm	2,540	2,640	—	—	—
Ground pressure	SK210LC	kPa	—	48	42	38	33
	SK210NLC	kPa	—	48	42	37	—
	SK210SNLC	kPa	59	49	—	—	—
Operating weight	SK210LC	kg	—	23,100	23,600	23,800	24,100
	SK210NLC	kg	—	23,000	23,500	23,700	—
	SK210SNLC	kg	23,500	23,700	—	—	—

In standard trim, with 2 Piece boom, 2.94 m arm, and 0.8 m<sup>3</sup> ISO heaped bucket (optional counterweight 4,800 kg).

Shaped			Triple grouser shoes (even height)			
Shoe width		mm	600	700	790	900
Overall width of crawler	SK210LC	mm	2,990	3,090	3,180	3,290
	SK210NLC	mm	2,800	2,900	2,990	—
Ground pressure	SK210LC	kPa	49	43	38	34
	SK210NLC	kPa	49	40	36	—
Operating weight	SK210LC	kg	23,600	24,100	24,300	24,600
	SK210NLC	kg	23,500	24,000	24,200	—



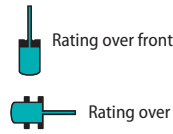
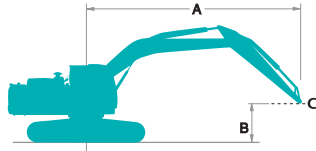









## Lift capacities





























A - Reach from swing centerline to arm top  
 B - Arm top height above/below ground  
 C - Lift point  
 Relief valve setting: 37.8 MPa













SK210LC		2 Piece boom		Arm: 2.94 m		Bucket: without		Counterweight: 4,300 kg		Shoe: 600 mm (Heavy Lift)				
B	A	1.5 m		3.0 m		4.5 m		6.0 m		7.5 m		At max. reach		
														Radius
9.0 m	kg					*5,880	*5,880					*4,930	*4,930	4.74 m
7.5 m	kg					*6,770	*6,770	*5,680	5,440			*4,040	*4,040	6.49 m
6.0 m	kg					*6,870	*6,870	*4,620	*4,620	*4,100	3,600	*3,700	3,550	7.55 m
4.5 m	kg			*10,460	*10,460	*9,180	8,220	*7,630	5,170	*4,820	3,560	*3,580	3,000	8.21 m
3.0 m	kg	*31,510	*31,510	*16,370	14,230	*10,810	7,440	7,780	4,830	*4,780	3,410	*3,610	2,720	8.55 m
1.5 m	kg			*17,860	12,690	*11,550	6,750	7,410	4,500	*5,140	3,250	*3,770	2,620	8.62 m
G.L.	kg	*19,950	*19,950	*14,860	12,300	*11,200	6,410	7,160	4,280	5,140	3,140	*4,100	2,670	8.42 m
-1.5 m	kg			*10,000	*10,000	*9,830	6,330	7,070	4,200	5,120	3,110	*4,690	2,910	7.93 m
-3.0 m	kg			*8,590	*8,590	*7,430	6,450	*5,640	4,270			*3,780	3,460	7.10 m
-4.5 m	kg			*11,920	*11,920	*6,720	*6,720					*1,810	*1,810	5.76 m

SK210LC		2 Piece boom		Arm: 3.50 m		Bucket: without		Counterweight: 4,300 kg		Shoe: 600 mm (Heavy Lift)				
B	A	1.5 m		3.0 m		4.5 m		6.0 m		7.5 m		9.0 m		At max. reach
														Radius
9.0 m	kg					*5,740	*5,740					*4,030	*4,030	5.53 m
7.5 m	kg							*4,890	*4,890			*3,460	*3,460	7.09 m
6.0 m	kg							*5,890	5,520	*4,460	3,700	*3,240	3,180	8.07 m
4.5 m	kg					*6,900	*6,900	*6,880	5,270	*4,150	3,600	*3,170	2,720	8.69 m
3.0 m	kg	*27,450	*27,450	*15,750	14,900	*10,210	7,660	*7,810	4,900	*4,070	3,420	*3,330	2,490	9.01 m
1.5 m	kg	*18,250	*18,250	*17,840	13,000	*11,280	6,880	7,450	4,530	*4,400	3,240	*3,890	2,410	9.08 m
G.L.	kg	*19,130	*19,130	*6,700	*6,700	*11,360	6,410	7,140	4,260	5,100	3,090	*3,710	2,400	8.89 m
-1.5 m	kg			*9,990	*9,990	*10,390	6,230	6,990	4,120	5,020	3,020	*4,220	2,580	8.43 m
-3.0 m	kg			*10,660	*10,660	*8,420	6,280	*6,380	4,130	*4,300	3,070	*4,000	3,000	7.65 m
-4.5 m	kg			*14,570	13,100	*5,130	*5,130	*4,490	4,340			*2,700	*2,700	6.43 m

SK210LC		2 Piece boom		Arm: 2.40 m		Bucket: without		Counterweight: 4,300 kg		Shoe: 600 mm (Heavy Lift)		At max. reach		Radius	
B	A	1.5 m		3.0 m		4.5 m		6.0 m		7.5 m					
															
9.0 m	kg												*7,980	*7,980	3.73 m
7.5 m	kg					*8,830	8,770						*6,060	5,550	5.80 m
6.0 m	kg					*9,000	8,570	*5,580	5,290				*5,130	4,010	6.97 m
4.5 m	kg			*14,150	*14,150	*10,110	7,990	*4,770	*4,770	*5,240	3,490		*4,720	3,330	7.68 m
3.0 m	kg			*15,800	14,260	*11,250	7,210	7,690	4,750	5,400	3,380		*4,580	3,000	8.05 m
1.5 m	kg			*17,890	12,860	11,600	6,630	7,360	4,460	5,260	3,250		*4,650	2,890	8.12 m
G.L.	kg	*25,320	*25,320	*15,660	12,430	*10,800	6,400	7,160	4,290	5,180	3,170		4,810	2,960	7.91 m
-1.5 m	kg			*9,810	*9,810	*9,050	6,410	*7,020	4,260				*4,810	3,270	7.39 m
-3.0 m	kg					*6,250	*6,250	*4,580	4,400				*3,540	*3,540	6.48 m

SK210LC		2 Piece boom		Arm: 2.94 m		Bucket: without		Counterweight: 4,800 kg		Shoe: 600 mm (Heavy Lift)		At max. reach		Radius	
B	A	1.5 m		3.0 m		4.5 m		6.0 m		7.5 m					
															
9.0 m	kg					*5,880	*5,880						*4,930	*4,930	4.74 m
7.5 m	kg					*6,770	*6,770	*5,680	*5,680				*4,040	*4,040	6.49 m
6.0 m	kg					*6,870	*6,870	*4,620	*4,620	*4,100	3,880		*3,700	*3,700	7.55 m
4.5 m	kg			*10,460	*10,460	*9,180	8,750	*7,630	5,530	*4,820	3,830		*3,580	3,520	8.21 m
3.0 m	kg	*31,510	*31,510	*16,370	15,220	*10,810	7,960	*8,150	5,190	*4,780	3,680		*3,610	2,960	8.55 m
1.5 m	kg			*17,860	13,680	*11,550	7,280	7,880	4,860	*5,140	3,520		*3,770	2,850	8.62 m
G.L.	kg	*19,950	*19,950	*14,860	13,290	*11,200	6,940	7,630	4,640	5,490	3,410		*4,100	2,910	8.42 m
-1.5 m	kg			*10,000	*10,000	*9,830	6,860	*7,480	4,560	5,460	3,390		*4,690	3,160	7.93 m
-3.0 m	kg			*8,590	*8,590	*7,430	6,980	*5,640	4,630				*3,780	3,750	7.10 m
-4.5 m	kg			*11,920	*11,920	*6,720	*6,720						*1,810	*1,810	5.76 m

SK210LC		2 Piece boom		Arm: 3.50 m		Bucket: without		Counterweight: 4,800 kg		Shoe: 600 mm (Heavy Lift)		At max. reach		Radius		
B	A	1.5 m		3.0 m		4.5 m		6.0 m		7.5 m		9.0 m				
																
9.0 m	kg					*5,740	*5,740						*4,030	*4,030	5.53 m	
7.5 m	kg							*4,890	*4,890				*3,460	*3,460	7.09 m	
6.0 m	kg							*5,890	5,880	*4,460	3,970		*3,240	*3,240	8.07 m	
4.5 m	kg					*6,900	*6,900	*6,880	5,630	*4,150	3,870		*3,170	2,950	8.69 m	
3.0 m	kg	*27,450	*27,450	*15,750	*15,750	*10,210	8,190	*7,810	5,260	*4,070	3,700	*3,330	2,710	*3,230	2,700	9.01 m
1.5 m	kg	*18,250	*18,250	*17,840	13,990	*11,280	7,410	7,920	4,890	*4,400	3,510	*3,890	2,630	*3,390	2,600	9.08 m
G.L.	kg	*19,130	*19,130	*6,700	*6,700	*11,360	6,930	7,610	4,620	*5,180	3,360		*3,710	2,630	8.89 m	
-1.5 m	kg			*9,990	*9,990	*10,390	6,760	7,460	4,480	5,370	3,290		*4,220	2,820	8.43 m	
-3.0 m	kg			*10,660	*10,660	*8,420	6,810	*6,380	4,490	*4,300	3,350		*4,000	3,270	7.65 m	
-4.5 m	kg			*14,570	14,090	*5,130	*5,130	*4,490	*4,490				*2,700	*2,700	6.43 m	

SK210LC		2 Piece boom		Arm: 2.40 m		Bucket: without		Counterweight: 4,800 kg		Shoe: 600 mm (Heavy Lift)		At max. reach		Radius	
B	A	1.5 m		3.0 m		4.5 m		6.0 m		7.5 m					
															
9.0 m	kg												*7,980	*7,980	3.73 m
7.5 m	kg					*8,830	*8,830						*6,060	5,920	5.80 m
6.0 m	kg					*9,000	*9,000	*5,580	*5,580				*5,130	4,310	6.97 m
4.5 m	kg			*14,150	*14,150	*10,110	8,520	*4,770	*4,770	*5,240	3,760		*4,720	3,600	7.68 m
3.0 m	kg			*15,800	15,250	*11,250	7,740	8,150	5,110	*5,500	3,650		*4,580	3,250	8.05 m
1.5 m	kg			*17,890	13,850	*11,600	7,160	7,830	4,820	5,610	3,520		*4,650	3,140	8.12 m
G.L.	kg	*25,320	*25,320	*15,660	13,420	*10,800	6,930	7,630	4,650	5,520	3,450		*4,930	3,220	7.91 m
-1.5 m	kg			*9,810	*9,810	*9,050	6,940	*7,020	4,620				*4,810	3,550	7.39 m
-3.0 m	kg					*6,250	*6,250	*4,580	*4,580				*3,540	*3,540	6.48 m



# SK210<sup>LC</sup>

SK210LC-11E

# SK210<sup>NLC</sup>

SK210NLC-11E

# SK210<sup>SNLC</sup>

SK210SNLC-11E

SK210NLC		2 Piece boom		Arm: 2.94 m		Bucket: without		Counterweight: 4,300 kg		Shoe: 600 mm (Heavy Lift)				
B	A	1.5 m		3.0 m		4.5 m		6.0 m		7.5 m		At max. reach		Radius
9.0 m	kg					*5,880	*5,880					*4,930	*4,930	4.74 m
7.5 m	kg					*6,770	*6,770	*5,680	5,000			*4,040	*4,040	6.49 m
6.0 m	kg					*6,870	*6,870	*4,620	*4,620	*4,100	3,290	*3,700	3,240	7.55 m
4.5 m	kg			*10,460	*10,460	*9,180	7,500	*7,630	4,730	*4,820	3,250	*3,580	2,730	8.21 m
3.0 m	kg	*31,510	*31,510	*16,370	12,600	*10,810	6,730	7,760	4,400	*4,780	3,100	*3,610	2,470	8.55 m
1.5 m	kg			*17,860	11,140	*11,550	6,070	7,390	4,070	*5,140	2,940	*3,770	2,370	8.62 m
G.L.	kg	*19,950	*19,950	*14,860	10,760	*11,200	5,730	7,140	3,860	5,130	2,830	*4,100	2,410	8.42 m
-1.5 m	kg			*10,000	*10,000	*9,830	5,660	7,050	3,780	5,100	2,810	*4,690	2,630	7.93 m
-3.0 m	kg			*8,590	*8,590	*7,430	5,770	*5,640	3,850			*3,780	3,130	7.10 m
-4.5 m	kg			*11,920	11,800	*6,720	6,140					*1,810	*1,810	5.76 m

SK210NLC		2 Piece boom		Arm: 3.50 m		Bucket: without		Counterweight: 4,300 kg		Shoe: 600 mm (Heavy Lift)						
B	A	1.5 m		3.0 m		4.5 m		6.0 m		7.5 m		9.0 m		At max. reach		
9.0 m	kg					*5,740	*5,740							*4,030	*4,030	5.53 m
7.5 m	kg							*4,890	*4,890					*3,460	*3,460	7.09 m
6.0 m	kg							*5,890	5,070	*4,460	3,390			*3,240	2,900	8.07 m
4.5 m	kg					*6,900	*6,900	*6,880	4,820	*4,150	3,290			*3,170	2,470	8.69 m
3.0 m	kg	*27,450	*27,450	*15,750	13,230	*10,210	6,950	*7,810	4,460	*4,070	3,120	*3,330	2,250	*3,230	2,240	9.01 m
1.5 m	kg	*18,250	*18,250	*17,840	11,430	*11,280	6,190	7,440	4,100	*4,400	2,930	*3,890	2,180	*3,390	2,140	9.08 m
G.L.	kg	*19,130	*19,130	*6,700	*6,700	11,330	5,730	7,130	3,830	5,090	2,780			*3,710	2,160	8.89 m
-1.5 m	kg			*9,990	*9,990	*10,390	5,560	6,970	3,700	5,010	2,720			*4,220	2,330	8.43 m
-3.0 m	kg			*10,660	*10,660	*8,420	5,610	*6,380	3,710	*4,300	2,770			*4,000	2,710	7.65 m
-4.5 m	kg			*14,570	11,520	*5,130	*5,130	*4,490	3,910					*2,700	*2,700	6.43 m

SK210NLC		2 Piece boom		Arm: 2.40 m		Bucket: without		Counterweight: 4,300 kg		Shoe: 600 mm (Heavy Lift)						
B	A	1.5 m		3.0 m		4.5 m		6.0 m		7.5 m		At max. reach		Radius		
9.0 m	kg													*7,980	*7,980	3.73 m
7.5 m	kg					*8,830	8,040							*6,060	5,080	5.80 m
6.0 m	kg					*9,000	7,840	*5,580	4,850					*5,130	3,670	6.97 m
4.5 m	kg			*14,150	*14,150	*10,110	7,270	*4,770	4,630	*5,240	3,180	*4,720	3,030	*4,720	3,030	7.68 m
3.0 m	kg			*15,800	12,620	*11,250	6,520	7,670	4,320	5,390	3,070	*4,580	2,730	*4,580	2,730	8.05 m
1.5 m	kg			*17,890	11,300	11,580	5,950	7,340	4,040	5,250	2,940	*4,650	2,620	*4,650	2,620	8.12 m
G.L.	kg	*25,320	*25,320	*15,660	10,890	*10,800	5,730	7,150	3,870	5,170	2,870	4,800	2,680	4,800	2,680	7.91 m
-1.5 m	kg			*9,810	*9,810	*9,050	5,740	*7,020	3,840					*4,810	2,960	7.39 m
-3.0 m	kg					*6,250	5,920	*4,580	3,980					*3,540	*3,540	6.48 m















SK210NLC		2 Piece boom		Arm: 2.94 m		Bucket: without		Counterweight: 4,800 kg		Shoe: 600 mm (Heavy Lift)						
B	A	1.5 m		3.0 m		4.5 m		6.0 m		7.5 m		At max. reach		Radius		
9.0 m	kg					*5,880	*5,880							*4,930	*4,930	4.74 m
7.5 m	kg					*6,770	*6,770	*5,680	5,340					*4,040	*4,040	6.49 m
6.0 m	kg					*6,870	*6,870	*4,620	*4,620	*4,100	3,560			*3,700	3,500	7.55 m
4.5 m	kg			*10,460	*10,460	*9,180	8,000	*7,630	5,080	*4,820	3,510	*3,580	2,970	*3,580	2,970	8.21 m
3.0 m	kg	*31,510	*31,510	*16,370	13,510	*10,810	7,230	*8,150	4,740	*4,780	3,360	*3,610	2,690	*3,610	2,690	8.55 m
1.5 m	kg			*17,860	12,050	*11,550	6,570	7,860	4,420	*5,140	3,210	*3,770	2,590	*3,770	2,590	8.62 m
G.L.	kg	*19,950	*19,950	*14,860	11,680	*11,200	6,230	7,610	4,200	5,470	3,090	*4,100	2,640	*4,100	2,640	8.42 m
-1.5 m	kg			*10,000	*10,000	*9,830	6,160	*7,480	4,120	5,450	3,070	*4,690	2,870	*4,690	2,870	7.93 m
-3.0 m	kg			*8,590	*8,590	*7,430	6,270	*5,640	4,190					*3,780	3,410	7.10 m
-4.5 m	kg			*11,920	*11,920	*6,720	6,640							*1,810	*1,810	5.76 m















**Notes:**















- Do not attempt to lift or hold any load that is greater than these lift capacities at their specified lift point radius and heights. Weight of all accessories must be deducted from the above lift capacities.
- Lift capacities are based on machine standing on level, firm, and uniform ground. User must make allowance for job conditions such as soft or uneven ground, out of level conditions, side loads, sudden stopping of loads, hazardous conditions, experience of personnel, etc.
- Arm top defined as lift point.
- The above lift capacities are in compliance with ISO 10567. They do not exceed 87% of hydraulic lift















capacity or 75% of tipping load. Lift capacities marked with an asterisk (\*) are limited by hydraulic capacity rather than tipping load.

- Operator should be fully acquainted with the Operator's and Maintenance Instructions before operating this machine. Rules for safe operation of equipment should be adhered to at all times.
- Lift capacities apply to only machine as originally manufactured and normally equipped by KOBELCO CONSTRUCTION MACHINERY CO., LTD.

SK210NLC		2 Piece boom		Arm: 3.50 m		Bucket: without		Counterweight: 4,800 kg		Shoe: 600 mm (Heavy Lift)						
B	A	1.5 m		3.0 m		4.5 m		6.0 m		7.5 m		9.0 m		At max. reach		
																Radius
9.0 m	kg					*5,740	*5,740							*4,030	*4,030	5.53 m
7.5 m	kg							*4,890	*4,890					*3,460	*3,460	7.09 m
6.0 m	kg							*5,890	5,420	*4,460	3,650			*3,240	3,140	8.07 m
4.5 m	kg					*6,900	*6,900	*6,880	5,170	*4,150	3,550			*3,170	2,690	8.69 m
3.0 m	kg	*27,450	*27,450	*15,750	14,140	*10,210	7,450	*7,810	4,810	*4,070	3,380	*3,330	2,460	*3,230	2,450	9.01 m
1.5 m	kg	*18,250	*18,250	*17,840	12,340	*11,280	6,690	7,910	4,450	*4,400	3,190	*3,890	2,390	*3,390	2,350	9.08 m
G.L.	kg	*19,130	*19,130	*6,700	*6,700	*11,360	6,230	7,590	4,180	*5,180	3,050			*3,710	2,380	8.89 m
-1.5 m	kg			*9,990	*9,990	*10,390	6,070	7,440	4,050	5,350	2,980			*4,220	2,550	8.43 m
-3.0 m	kg			*10,660	*10,660	*8,420	6,110	*6,380	4,060	*4,300	3,030			*4,000	2,970	7.65 m
-4.5 m	kg			*14,570	12,430	*5,130	*5,130	*4,490	4,260					*2,700	*2,700	6.43 m

SK210NLC		2 Piece boom		Arm: 2.40 m		Bucket: without		Counterweight: 4,800 kg		Shoe: 600 mm (Heavy Lift)						
B	A	1.5 m		3.0 m		4.5 m		6.0 m		7.5 m		At max. reach				
																Radius
9.0 m	kg													*7,980	*7,980	3.73 m
7.5 m	kg					*8,830	8,540							*6,060	5,440	5.80 m
6.0 m	kg					*9,000	8,340	*5,580	5,190					*5,130	3,950	6.97 m
4.5 m	kg			*14,150	*14,150	*10,110	7,770	*4,770	*4,770	*5,240	3,440			*4,720	3,290	7.68 m
3.0 m	kg			*15,800	13,530	*11,250	7,020	8,140	4,670	*5,500	3,330			*4,580	2,970	8.05 m
1.5 m	kg			*17,890	12,210	*11,600	6,450	7,810	4,380	5,590	3,210			*4,650	2,860	8.12 m
G.L.	kg	*25,320	*25,320	*15,660	11,800	*10,800	6,230	7,610	4,210	5,510	3,130			*4,930	2,930	7.91 m
-1.5 m	kg			*9,810	*9,810	*9,050	6,240	*7,020	4,190					*4,810	3,230	7.39 m
-3.0 m	kg					*6,250	*6,250	*4,580	4,330					*3,540	*3,540	6.48 m

SK210SNLC		2 Piece boom		Arm: 2.94 m		Bucket: without		Counterweight: 4,900 kg		Shoe: 500 mm (Heavy Lift)						
B	A	1.5 m		3.0 m		4.5 m		6.0 m		7.5 m		At max. reach				
																Radius
9.0 m	kg					*5,330	*5,330							*4,460	*4,460	4.74 m
7.5 m	kg					*6,130	*6,130	*5,100	4,980					*3,650	*3,650	6.49 m
6.0 m	kg					*6,210	*6,210	*4,130	*4,130	*3,700	3,300			*3,340	3,250	7.55 m
4.5 m	kg			*9,450	*9,450	*8,300	7,420	*6,810	4,720	*4,310	3,260			*3,230	2,750	8.21 m
3.0 m	kg	*28,190	*28,190	*14,620	12,230	*9,640	6,670	*7,250	4,390	*4,270	3,120			*3,250	2,490	8.55 m
1.5 m	kg			*15,880	10,830	*10,260	6,020	*7,530	4,080	*4,590	2,960			*3,400	2,390	8.62 m
G.L.	kg	*18,160	*18,160	*13,120	10,470	*9,920	5,690	*7,370	3,860	*5,260	2,850			*3,700	2,430	8.42 m
-1.5 m	kg			*9,060	*9,060	*8,660	5,620	*6,600	3,790	*4,800	2,830			*4,100	2,650	7.93 m
-3.0 m	kg			*7,450	*7,450	*6,500	5,730	*4,930	3,850					*3,270	3,150	7.10 m
-4.5 m	kg			*10,510	*10,510	*5,880	*5,880							*1,470	*1,470	5.76 m

SK210SNLC		2 Piece boom		Arm: 2.40 m		Bucket: without		Counterweight: 4,900 kg		Shoe: 500 mm (Heavy Lift)						
B	A	1.5 m		3.0 m		4.5 m		6.0 m		7.5 m		At max. reach				
																Radius
9.0 m	kg													*7,240	*7,240	3.73 m
7.5 m	kg					*7,980	7,940							*5,450	5,060	5.80 m
6.0 m	kg					*8,150	7,750	*5,010	4,840					*4,600	3,680	6.97 m
4.5 m	kg			*12,700	*12,700	*9,050	7,190	*4,260	*4,260	*4,690	3,200			*4,220	3,050	7.68 m
3.0 m	kg			*14,110	12,250	*10,030	6,460	*7,470	4,320	*4,920	3,090			*4,090	2,750	8.05 m
1.5 m	kg			*15,910	10,990	*10,310	5,910	*7,600	4,040	*5,250	2,960			*4,150	2,640	8.12 m
G.L.	kg	*22,430	*22,430	*13,860	10,590	*9,550	5,690	*7,240	3,880	*5,430	2,890			*4,400	2,700	7.91 m
-1.5 m	kg			*8,560	*8,560	*7,970	5,700	*6,190	3,850					*4,210	2,980	7.39 m
-3.0 m	kg					*5,430	*5,430	*3,980	*3,980					*3,050	*3,050	6.48 m

Notes:

- Do not attempt to lift or hold any load that is greater than these lift capacities at their specified lift point radius and heights. Weight of all accessories must be deducted from the above lift capacities.
- Lift capacities are based on machine standing on level, firm, and uniform ground. User must make allowance for job conditions such as soft or uneven ground, out of level conditions, side loads, sudden stopping of loads, hazardous conditions, experience of personnel, etc.
- Arm top defined as lift point.
- The above lift capacities are in compliance with ISO 10567. They do not exceed 87% of hydraulic lift capacity or 75% of tipping load. Lift capacities marked with an asterisk (\*) are limited by hydraulic capacity rather than tipping load.
- Operator should be fully acquainted with the Operator's and Maintenance Instructions before operating this machine. Rules for safe operation of equipment should be adhered to at all times.
- Lift capacities apply to only machine as originally manufactured and normally equipped by KOBELCO CONSTRUCTION MACHINERY CO., LTD.

## Long Reach Attachment Specifications

### Working ranges

Unit: mm

Boom	8.75 m
Arm	6.35 m
Range	6.35 m
a- Max. digging reach	15,820
b- Max. digging reach at ground level	15,710
c- Max. digging depth	12,010
d- Max. digging height	13,900
e- Max. dumping clearance	11,530
f- Min. dumping clearance	2,080
g- Max. vertical wall digging depth	11,190
h- Min. swing radius	4,730
i- Horizontal digging stroke at ground level	11,610
j- Digging depth for 2.4 m (8') flat bottom	11,910
Bucket capacity ISO heaped m <sup>3</sup>	0.45

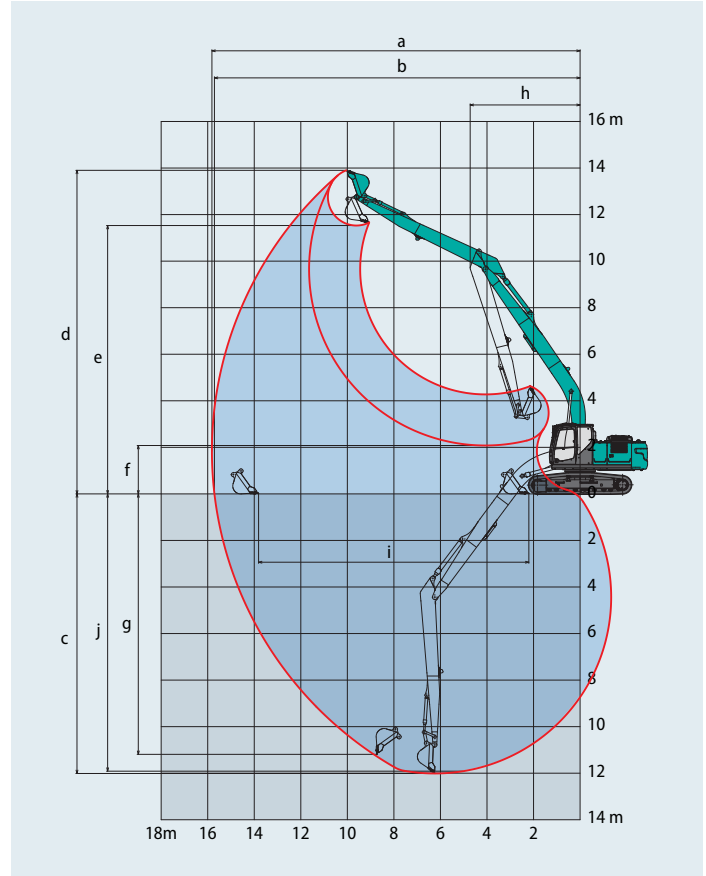

### Digging Force (ISO 6015)

Unit: kN

Arm length	Standard 6.35 m
Bucket digging force	88
Arm crowding force	54

### Dimensions (SK210LC)

Arm length	Standard 6.35 m
A Overall length	12,690
B Overall height (to top of boom)	3,160
C Overall width of crawler	2,990
D Overall height (to top of cab)	3,060
E Ground clearance of rear end*	1,060
F Ground clearance*	425

Unit: mm

G Tail swing radius	2,910
G' Distance from centre of swing to rear end	2,900
H Tumbler distance	3,660
I Overall length of crawler	4,450
J Track gauge	2,390
K Shoe width	600
L Overall width of upperstructure	2,710

\*Without including height of shoe

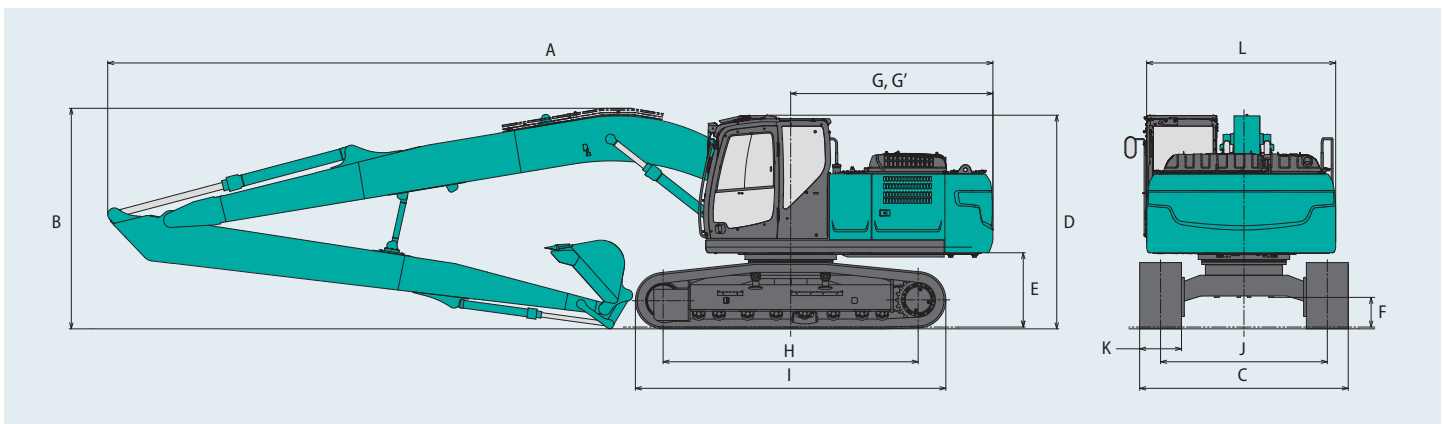



# Operating weight & ground pressure

In standard trim, with 8.75 m boom, 6.35 m arm, and 0.45 m<sup>3</sup> ISO heaped bucket.

Shaped		Triple grouser shoes (even height)			
Shoe width	mm	600	700	790	900
Overall width of crawler	mm	2,990	3,090	3,180	3,290
Ground pressure	kPa	49	43	38	34
Operating weight	kg	23,600	24,100	24,300	24,600

## Lift capacities

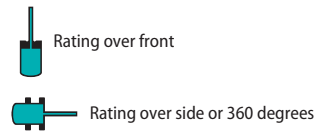
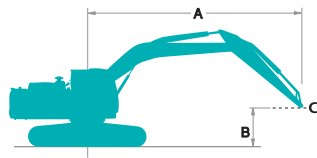

A - Reach from swing centerline to arm top  
 B - Arm top height above/below ground  
 C - Lift point  
 Relief valve setting: 34.3 MPa

SK210LC		Boom: 8.75 m Arm: 6.35 m Bucket: without Counterweight: 5,490 kg Shoe: 600mm																						
B	A	1.5 m		3.0 m		4.5 m		6.0 m		7.5 m		9.0 m		10.5 m		12.0 m		13.5 m		At max. reach		Radius		
12.0 m	kg																				*1,080	*1,080	10.44 m	
10.5 m	kg													*1,880	*1,880							*1,000	*1,000	11.72 m
9.0 m	kg													*2,220	*2,220	*1,620	*1,620					*950	*950	12.70 m
7.5 m	kg													*2,430	*2,430	*2,070	*2,070					*930	*930	13.44 m
6.0 m	kg													*2,560	*2,560	*2,400	2,060	*1,510	*1,510			*930	*930	13.98 m
4.5 m	kg												*3,020	*3,020	*2,740	2,520	*2,550	1,980	*1,900	1,560		*940	*940	14.35 m
3.0 m	kg			*5,190	*5,190	*6,520	*6,520	*4,810	*4,810	*3,890	*3,890	*3,330	3,050	*2,950	2,380	*2,680	1,880	*2,190	1,500		*970	*970	14.54 m	
1.5 m	kg					*7,340	7,280	*5,600	4,990	*4,380	3,680	*3,640	2,830	*3,160	2,230	*2,810	1,780	2,350	1,440		*1,020	*1,020	14.58 m	
G.L.	kg			*2,060	*2,060	*4,980	*4,980	*6,190	4,520	*4,780	3,380	*3,910	2,630	*3,340	2,090	2,760	1,690	2,300	1,380		*1,090	*1,090	14.47 m	
-1.5 m	kg	*2,040	*2,040	*2,810	*2,810	*4,960	*4,960	*6,520	4,230	*5,050	3,160	4,040	2,470	3,250	1,990	2,680	1,620	2,250	1,340		*1,180	*1,180	14.19 m	
-3.0 m	kg	*2,940	*2,940	*3,720	*3,720	*5,610	*5,610	*6,610	4,090	5,070	3,030	3,930	2,370	3,170	1,910	2,630	1,570	*1,860	1,320		*1,320	1,290	13.75 m	
-4.5 m	kg	*3,880	*3,880	*4,740	*4,740	*6,630	6,140	*6,480	4,040	5,010	2,970	3,880	2,320	3,140	1,880	2,620	1,560				*1,510	1,380	13.11 m	
-6.0 m	kg	*4,890	*4,890	*5,910	*5,910	*7,960	6,250	*6,120	4,080	*4,890	2,980	3,880	2,320	3,150	1,890	*2,580	1,590				*1,800	1,550	12.26 m	
-7.5 m	kg	*6,030	*6,030	*7,300	*7,300	*7,040	6,440	*5,510	4,190	*4,440	3,050	*3,620	2,380	*2,900	1,950							*2,290	1,820	11.15 m
-9.0 m	kg			*7,450	*7,450	*5,700	*5,700	*4,550	4,380	*3,660	3,200	*2,860	2,520									*2,470	2,310	9.67 m
-10.5 m	kg					*3,700	*3,700	*2,980	*2,980	*2,190	*2,190											*2,110	*2,110	7.62 m

### Notes:

- Do not attempt to lift or hold any load that is greater than these lift capacities at their specified lift point radius and heights. Weight of all accessories must be deducted from the above lift capacities.
- Lift capacities are based on machine standing on level, firm, and uniform ground. User must make allowance for job conditions such as soft or uneven ground, out of level conditions, side loads, sudden stopping of loads, hazardous conditions, experience of personnel, etc.
- Arm top defined as lift point.
- The above lift capacities are in compliance with ISO 10567. They do not exceed 87% of hydraulic lift capacity or 75% of tipping load. Lift capacities marked with an asterisk (\*) are limited by hydraulic capacity rather than tipping load.
- Operator should be fully acquainted with the Operator's and Maintenance Instructions before operating this machine. Rules for safe operation of equipment should be adhered to at all times.
- Lift capacities apply to only machine as originally manufactured and normally equipped by KOBELCO CONSTRUCTION MACHINERY CO., LTD.



# Standard and Optional Equipment

● =Std ○ =Opt — = N/A

Category	Description	SK210(N)LC-11E			
		Mono boom / 2 Piece boom			Long Reach
		LC	NLC	SNLC	LC
ENGINE	YANMAR 4TN107FTT (EU Stage V compliant)	●	●	●	●
	Exhaust DOC DPF SCR system	●	●	●	●
	Alternator 24 V/80 A	●	●	●	●
	Starter motor 24 V/5 kW	●	●	●	●
	Batteries 2 x 12 V (130 Ah)	●	●	●	●
	Fan suction type cooling system	●	●	●	●
	Auto deceleration function	●	●	●	●
	Auto Idle Stop (AIS)	●	●	●	●
HYDRAULIC SYSTEM	3 work modes H, S, Eco	●	●	●	●
	Power boost (37.8 MPa)	●	●	●	—
	Heavy lift mode	●	●	●	—
	Pressure release function	●	●	●	●
	Independent travel function	●	●	●	●
	Auto warm up system	●	●	●	●
	Proportional Hand Control (for E&N&B piping)	—	—	—	—
	Proportional Hand Control (for Extra piping)	—	—	—	●
	Hydraulic oil VG32	●	●	●	●
	Hydraulic oil VG46	○	○	○	○
	Hydraulic oil VG68	○	○	○	○
	PIPING	E & N&B piping	●	●	●
E & N&B piping + Bigger capacity P4 pump (89.4 L/min)		—	○	—	—
Standard piping (only mono boom spec)		○	—	—	—
Extra piping		—	—	—	●
CABIN	QH piping	●	●	●	●
	Air suspension seat with heating	●	●	●	●
	10 inch colour monitor	●	●	●	●
	LED door light	●	●	●	●
	Air-conditioner	●	●	●	●
	DAB+ radio (FM/AM & AUX & USB & Bluetooth* & hands free telephone)	●	●	●	●
	Harness for CAB four lights and CAB yellow flasher	●	●	●	●
	Parallel wiper	●	●	●	●
	12 V power outlet	●	●	●	●
	Rain visor	○	○	○	○
	Sun screen	●	●	●	●
LIGHTS	Large footrest	●	●	●	●
	LED work lights ; 2 on boom, 1 on upper frame, 2 on rear counterweight	●	●	●	●
WORKING EQUIPMENT	LED work lights ; 2 on CAB top front	○	○	○	○
	Standard Boom (5.65 m)	●	●	●	—
	2 Piece Boom	○	○	○	—
	Long Reach (50 ft)	—	—	—	●
	Standard HD arm (2.94 m) with rock guard	●	●	○	—
	Short HD arm (2.40 m) with rock guard	○	○	●	—
	Long HD arm (3.50 m) with rock guard	○	○	—	—
	Long Reach arm (6.35 m)	—	—	—	●
COUNTERWEIGHT	Bucket link with lifting hook	●	●	●	●
	Standard C/W (TTL 4,300 kg)	●	●	—	—
	Standard C/W (TTL 4,900 kg)	—	—	●	—
	Semi heavier C/W (TTL 4,800 kg)	○	○	—	—
	Heavier C/W (TTL 5,490 kg)	—	—	—	●
UNDERCARRIAGE	500 mm steel shoe	—	—	●	—
	600 mm steel shoe	●	●	○	●
	700 mm steel shoe	○	○	—	○
	790 mm steel shoe	○	○	—	○
	900 mm steel shoe	○	—	—	○
	Track guide (one per side)	●	●	●	●
	Additional track guides (two additional per side)	○	○	○	○
	Lower frame guard	●	●	●	●
SAFETY	Engine emergency stop switch	●	●	●	●
	Pump emergency mode (KPSS release switch)	●	●	●	●
	Emergency accel dial	●	●	●	●
	Emergency manual valve for lowering attachment	●	●	●	●
	Overload alarm	●	●	●	●
	Safety valve for boom & arm cylinder	●	●	●	●
	ROPS compliant cab (ISO 12117-2:2008)	●	●	●	●
	OPG Level II top guard (ISO 10262:1998)	●	●	●	●
	OPG Level II front guard (ISO 10262:1998)	○	○	○	○
	Eagle-eye view camera (Rear, Right, Left)	●	●	●	●
	Seatbelt indicator on display	●	●	●	●
	Travel alarm	○	○	—	○
	Extended guard rail	○	○	○	○
	Emergency escape hammer	●	●	●	●
OTHERS	Refueling pump	●	●	●	●
	Harness for engine room light	●	●	●	●
	RAL color	○	○	○	○
	KOMEXS	●	●	●	●

\*The air conditioning system on this machine contains fluorinated greenhouse gas HFC-134a (GWP 1430). Quantity of gas 0.8 kg (CO<sub>2</sub> equivalent 1.3 t).  
Note: Bluetooth\* is a registered trademark of the Bluetooth SIG Inc.

Note: This catalogue may contain attachments and optional equipment that are not available in your area. And it may contain photographs of machines with specifications that differ from those of machines sold in your areas. Please consult your nearest KOBELCO distributor for those items you require.

Specialist equipment is needed to use this machine in demolition work. Before using it please contact your KOBELCO dealer.

Due to our policy of continuous product improvements all designs and specifications are subject to change without advance notice.

Copyright by **KOBELCO CONSTRUCTION MACHINERY CO., LTD.** No part of this catalogue may be reproduced in any manner without notice.

## KOBELCO CONSTRUCTION MACHINERY EUROPE B.V.

Veluwezoom 15  
1327 AE Almere  
The Netherlands  
www.kobelco-europe.com

Enquiries To: